

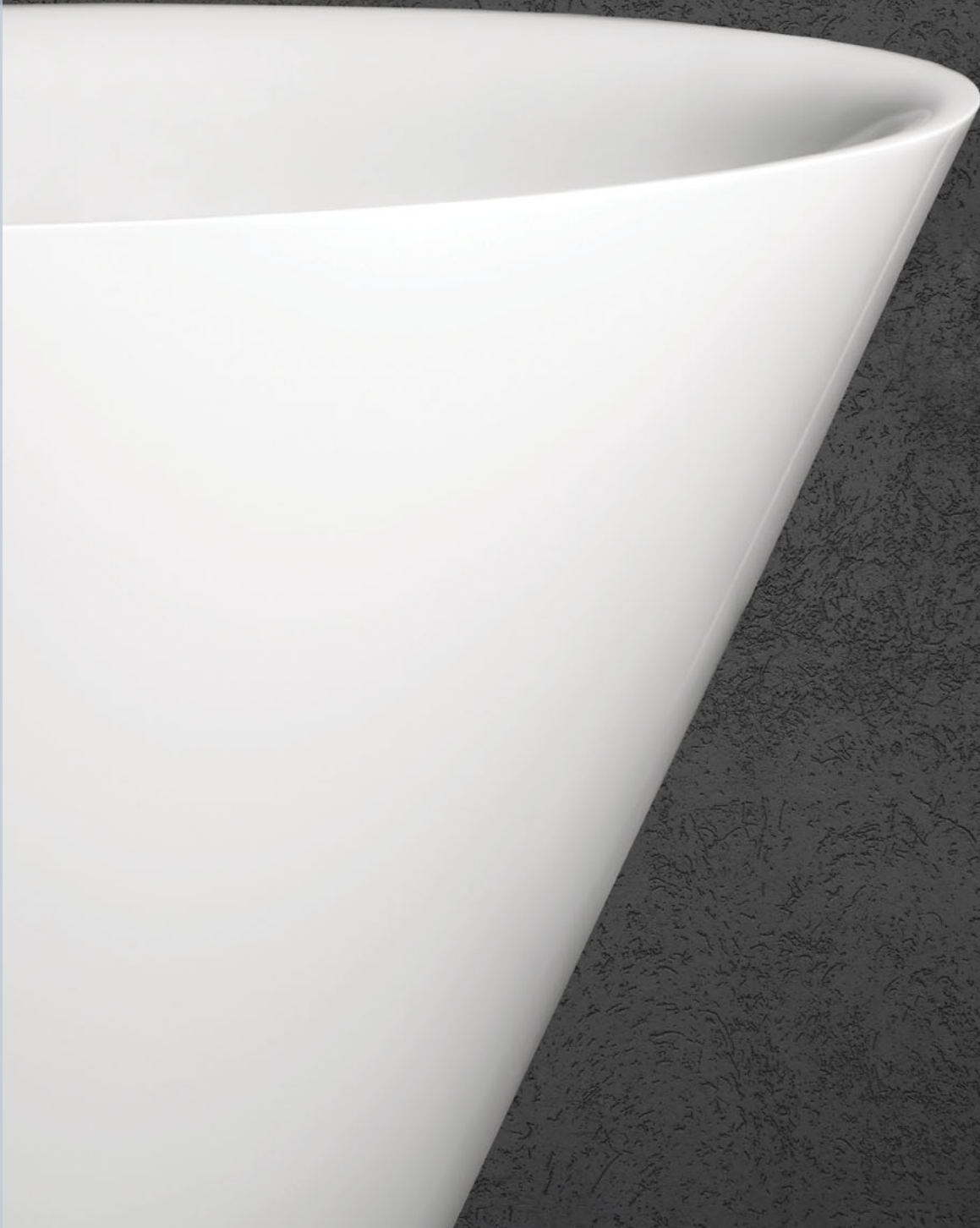

Price list 2025



CONTENT

Freestanding baths

INFINITY
1795 × 795 mm



p. 4.

VICTORIA
1700 × 830 mm



p. 4.

BELLA
1705 × 800 mm



p. 5.

BELLA OVO **NEW**
1700 × 800 mm



p. 5.

FELICE
1945 × 830 mm



p. 6.

AMORE
1600 × 850 mm



p. 6.

DOLCE
1800 × 900 mm



p. 7.

STORIA
1670 × 725 mm



p. 7.

PERLA 145 **NEW**
1450 × 710 mm



p. 8.

PERLA 160
1600 × 750 mm



p. 8.

PERLA 175 **NEW**
1750 × 760 mm



p. 8.

STEP
1700 × 890 mm



p. 9.

BEL CANTO
1800 × 850 mm



p. 9.

DECO collection baths

DECO NUDO
1660 × 725 mm



p. 10.

DECO RIM
1660 × 810 mm



p. 10.

DECO WALL
1660 × 810 mm



p. 10.

DECO CORNER
1600 × 1270 mm



p. 11.

DECO SHAPE
1660-2500 × 725-1250 mm



p. 11.

DECO SHAPE RE
1700-2000 × 825 mm



p. 12.

DECO SHAPE RE A/D
1700-2000 × 825 mm



p. 12.

Made to Measure concept baths

QUADRO collection baths

QUADRO
1590 × 700 mm

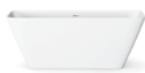

p. 13.

QUADRO CORNER A/D
1600 × 750 mm



p. 13.

QUADRO WALL
1600 × 760 mm

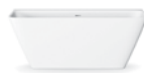

p. 13.

VARIO collection baths

VARIO M
1500-1600 × 750 mm



p. 14.-15.

VARIO L
1600-1700 × 750 mm



p. 14.-15.

VARIO XL
1750-1850 × 800 mm



p. 14.-15.

UNO, TRE collection baths

UNO 150
1500 × 750 mm



p. 16.

UNO 170
1700 × 750 mm



p. 16.

TRE 150 A/D
1500 × 1000 mm



p. 16.

TRE 170 A/D
1700 × 1000 mm



p. 17.

VERSO baths

VERSO
1700 × 750 mm



p. 17.

Made to Measure washbasins

OPUS MINI / OPUS



p. 18.- 19.

OPUS GRANDE



p. 20.

STRETTO



p. 21.

ROUND



p. 22.

OVO



p. 23.

PIANO



p. 24.

CREDO



p. 25.

QUADRO



p. 26.

FLOW 45/50



p. 28.

Made to Measure Cast Stone washbasins



p. 30.-32.

Furniture, shelves, surfaces and wall panels

Made to Measure surfaces.
ON-TOP washbasins



p. 32.- 37.

Made to Measure shelves



p. 38.

SOLID
countertops in oak



p. 38.

Made to Measure
wall panels



p. 39.

Washbasins

BELLA



p. 40.

FELICE



p. 40.

AMORE



p. 40.

PERLA



p. 40.

QUADRO



p. 41.

QUADRO ON



p. 41.

INFINITY 80



p. 41.

INFINITY 60



p. 41.

DECO



p. 42.

ROUND ON



p. 42.

VARIO



p. 42.

OVO IN



p. 43.

ROUND IN



p. 43.

OPUS IN



p. 43.

ORGANIC IN



p. 43.

LONG STEP
washbasins



p. 44.

LOTO MINI/ LOTO
washbasins



p. 45.

SAMBA 55 / SAMBA 70



p. 46.

STEP MINI/
STEP



p. 46.

VICTORIA



p. 46.

BETA



p. 47.

DELTA



p. 47.

CLARO
washbasins



p. 48.

X-small washbasins

DO 22



p. 49.

DO 25



p. 49.

DO 28



p. 49.

RE



p. 49.

MI



p. 49.

Cast Stone shower trays

CLASSIC KV



p. 50.

CLASSIC RO



p. 50.

CLASSIC NEW



p. 50.

ART KV



p. 51.

ART RO



p. 51.

ART



p. 51.

LARGO



p. 52.

LETTERA **NEW**



p. 53.

CRAFT Made to Measure shower tray



p. 54.

Technical information

product code generation, product tint/colour
cards, warranty terms, etc.

p. 55.- 59.

Item	Description	Price EUR		Art. NR.
		White	In colour	White / In colour



INFINITY
 1795 × 795 mm
 h = 620 mm
 Volume: 300 l
 Weight: 165 kg
 Integrated push-open drain-overflow (included)

Bath in Silkstone® with side panels	6500		VAINFS/00
Built-in Silkstone® bath (without side panels)	4500		VAINFSIEB/00
White bath in Silkstone® with tinted side panels		7550	VAINFS/xx

Accessory kit in ash tree and Technogel headrest included

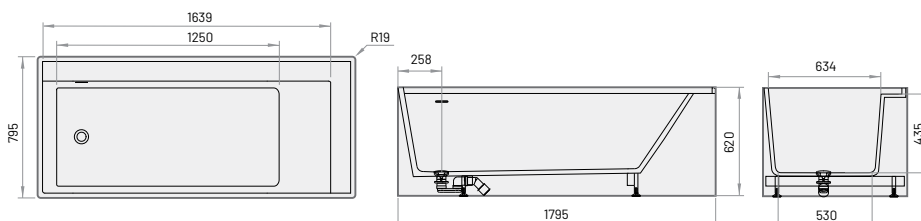

ANTICA (Silkstone®) legs



ANTICA (GRAPHITE) legs

VICTORIA
 1700 × 830 × 610 mm
 h = 730, 680 mm
 Volume: 225 l
 Weight: 84 / 80 kg

Bath in Cast Stone, ANTICA legs in Cast Stone	2900	3900	VAVICA/xx
Bath in Silkstone®, ANTICA legs in Silkstone®	3750		VAVISS/00
Bath in Silkstone®, ANTICA legs in GRAPHITE	5000		VAVISG/00

Optional:

Drain-overflow in metal, chrome colour	330		SIFVICM/H
Drain-overflow in metal, bronze colour	570		SIFVICM/B
Drain-overflow in metal, gold colour	710		SIFVICM/Z

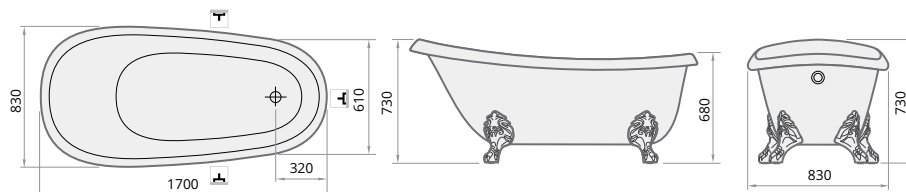

Item	Description	Price EUR		Art. NR.
		White	In colour	White / In colour



BELLA
 1705 × 800 mm
 h = 550 mm
 Volume: 312 l
 Weight: 135/113 kg
 Integrated
 push-open
 drain-overflow
 (included)

Bath in Cast Stone	2700	3500	VABELL/xx
Bath in Silkstone®	3550	4100	VABELS/xx
Bath in GRAPHITE		4850	VABELS/01

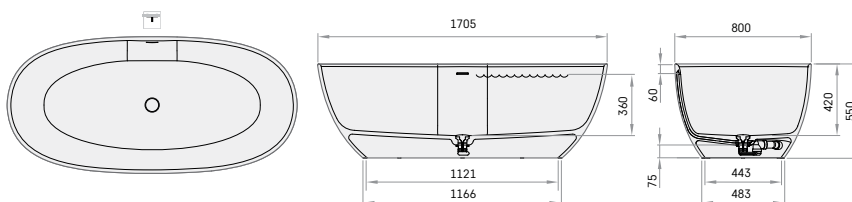

NEW



BELLA OVO
 1700 × 800 mm
 h = 550 mm
 Volume: 275 l
 Weight: 111/93 kg
 Integrated
 push-open
 drain-overflow
 (included)

Bath in Cast Stone	2700	3500	VABELLO/xx
Bath in Silkstone®	3550	4100	VABELLOS/xx
Bath in GRAPHITE		4850	VABELLOS/01

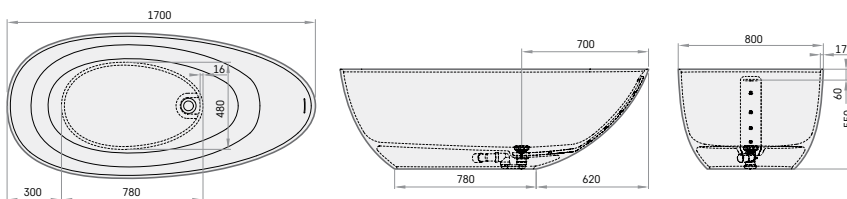

Item	Description	Price EUR		Art. NR.
		White	In colour	White / In colour



FELICE
 1945 × 830 mm
 h = 715 mm
 Volume: 280 l
 Weight: 128 kg
 Integrated
 push-open
 drain-overflow
 (included)

Bath in Silkstone®	3700	4300	VAFES/xx
Bath in GRAPHITE		5000	VAFES/01

NOTE! FELICE bath requires a 50 mm recess in the floor for the drain
 (see. installation manual www.paabaths.com)

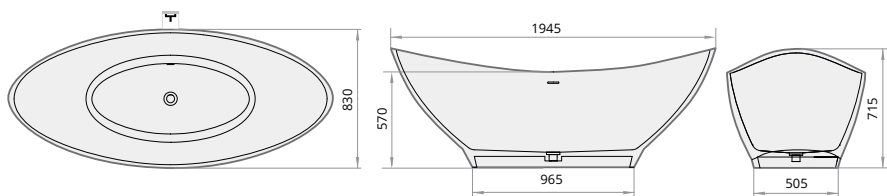

AMORE
 1600 × 850 mm
 h = 715 mm
 Volume: 260 l
 Weight: 162 / 130 kg
 Integrated
 push-open
 drain-overflow
 (included)

Bath in Cast Stone	2550	3300	VAAMO/xx
Bath in Silkstone®	3400	3950	VAAMS/xx
Bath in GRAPHITE		4700	VAAMS/01

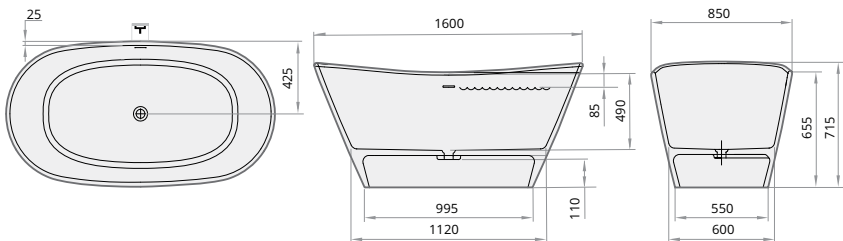

Item	Description	Price EUR		Art. NR.
		White	In colour	White / In colour



DOLCE
 1800 x 900 mm
 h = 650 mm
 Volume: 260 l
 Weight: 145 / 148 kg
 Integrated
 push-open
 drain-overflow
 (included)

Bath in Silkstone®	4000		VADOS/00
Bath in GRAPHITE		5350	VADOS/01

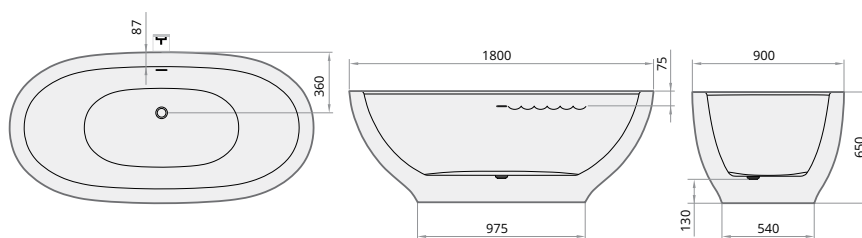

STORIA
 1670 x 725 mm
 h = 595 mm
 Volume: 240 l
 Weight: 136 kg
 Integrated
 push-open
 drain-overflow
 (included)

Bath in Cast Stone	2250	2900	VASTO/xx
--------------------	------	------	----------

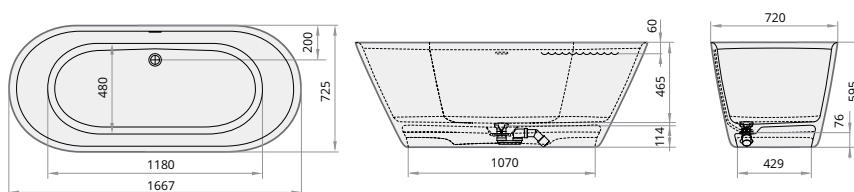

Item	Description	Price EUR		Art. NR. White / In colour
		White	In colour	

NEW



PERLA 145
 1450 × 710 mm
 h = 600 mm
 Volume: 260 l
 Weight: 105/84 kg
 Integrated
 push-open
 drain-overflow
 (included)

Bath in Cast Stone	2250	2900	VAPERL145/xx
Bath in Silkstone®	3150	3600	VAPERLS145/xx
Bath in GRAPHITE		4400	VAPERLS145/01

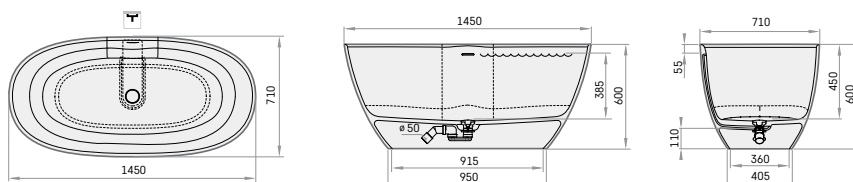

NEW



PERLA 160
 1600 × 750 mm
 h = 600 mm
 Volume: 275 l
 Weight: 107/85 kg
 Integrated
 push-open
 drain-overflow
 (included)

Bath in Cast Stone	2400	3050	VAPERL/xx
Bath in Silkstone®	3300	3750	VAPERLS/xx
Bath in GRAPHITE		4450	VAPERLS/01

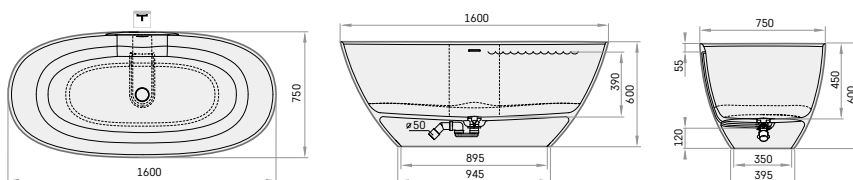

NEW



PERLA 175
 1750 × 760 mm
 h = 600 mm
 Volume: 315 l
 Weight: 120/97 kg
 Integrated
 push-open
 drain-overflow
 (included)

Bath in Cast Stone	2800	3650	VAPERL175/xx
Bath in Silkstone®	3650	4200	VAPERLS175/xx
Bath in GRAPHITE		4950	VAPERLS175/01

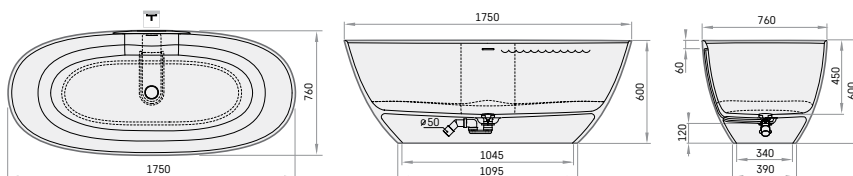

Item	Description	Price EUR		Art. NR.
		White	In colour	White / In colour



STEP
 1700 × 890 mm
 h = 650 mm
 Volume: 375 l
 Weight: 133 kg

Bath in Cast Stone	1850	2500	VASTE/xx
Drain-overflow chromed plastic	110	110	SIFVPAA80/00
TOTAL	1960	2610	

Optional:

Cut-outs for mixer tap	100		RURBPB
Drain-overflow black metal plastic	210		SIFVPAA80/01

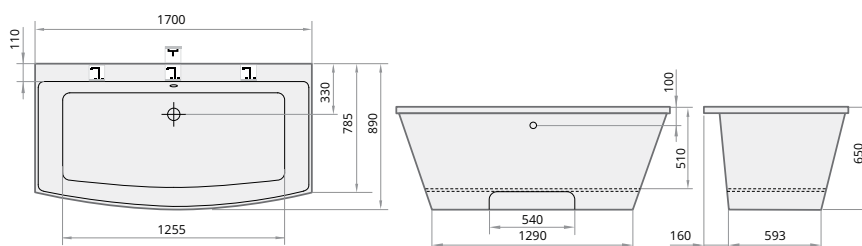

BEL CANTO
 1800 × 850 mm
 h = 740 mm
 Volume: 245 l
 Weight: 100 kg

Bath in Cast Stone	1850	2500	VABEL/xx
Drain-overflow chromed plastic	110	110	SIFVPAA80/00
TOTAL	1960	2610	

Optional:

Push-open drain-overflow in chrome	310		SIFVBELM/H
Drain-overflow black metal plastic	210		SIFVPAA80/01

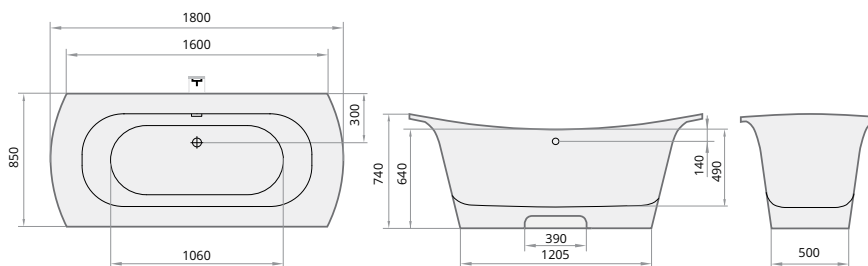

Item	Description	Price EUR		Art. NR.
		White	In colour	White / In colour



DECO NUDO

1660 × 725 mm
h = 630 mm
Volume: 240 l
Weight: 112 kg
Integrated push-open drain-overflow (included)

Bath in Cast Stone*	2250	2900	VADENU/xx
Bath in Silkstone®*	2850	3400	VADENUS/xx
Bath in GRAPHITE		4150	VADENUS/01

* When ordering a tinted bath, the colour name must be indicated in the order notes, the entire bathtub is tinted (See Silkstone® tints on page 58./ Cast Stone colours on page 57).

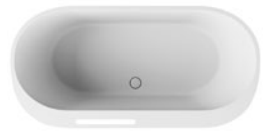
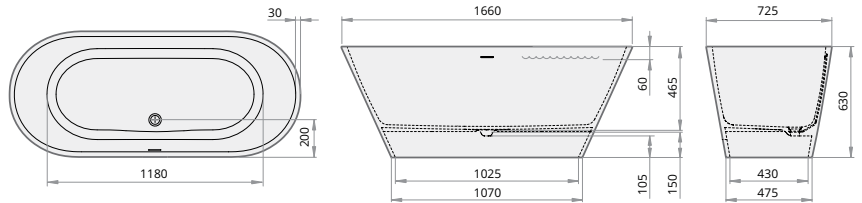

DECO RIM

1660 × 810 mm
h = 630 mm
Volume: 240 l
Weight: 110 kg
Integrated push-open drain-overflow (included)

Bath in Silkstone®*	3300	3800	VADERIS/xx
Bath in GRAPHITE		4450	VADERIS/01

The position of the towel holder (A or D, see drawing) must be indicated in the order notes.

* When ordering a tinted bath, the colour name must be indicated in the order notes, the entire bathtub is tinted (see Silkstone tints on page 58).

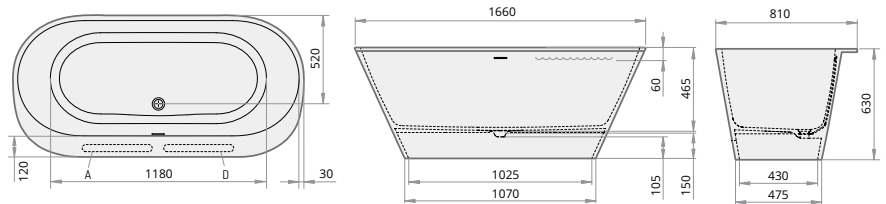

DECO WALL

1660 × 810 mm
h = 630 mm
Volume: 240 l
Weight: 120 kg
Integrated push-open drain-overflow (included)

Bath in Silkstone®*	3300	3800	VADEWAS/XX
Bath in GRAPHITE		4450	VADEWAS/01

Optional:

Cut-out for connection to the sewerage system (B/C)	90	RFREZSS
Cut-outs for mixer taps	100	

* The location of the cut-outs for the mixer tap and the location of the sewerage hole must be indicated in the order notes.

When ordering a tinted bath, the colour name must be indicated in the order notes, the entire bathtub is tinted (see Silkstone tints on page 58).

Attention! According to an EU industry standard, not all mixer taps are suitable for placement on the edge of this bathtub.

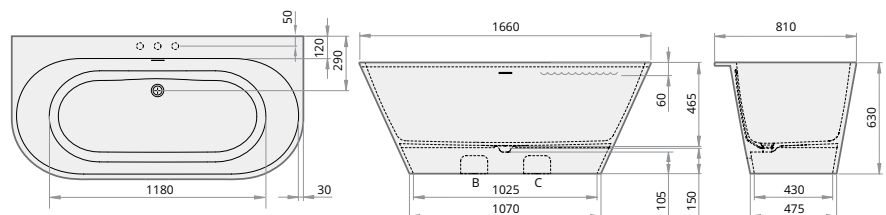

Item	Description	Price EUR		Art. NR.
		White	In colour	White / In colour



DECO CORNER D, 1600x1270

DECO CORNER
D/A, 1600 × 1270 mm
h = 630 mm
Volume: 240 l
Weight: 120 kg
Integrated push-open drain-overflow (included)

Bath in Silkstone® DECO CORNER D, 1600 × 1270*	4050	4650	VADECORS/00
Bath in Silkstone® DECO CORNER A, 1600 × 1270*	4050	4650	VADECORSA/00

Optional:

Cut-out for connection to the sewerage system (B/C)	90	RFREZSS
Cut-outs for mixer taps	100	

* Only the surface of a bathtub is tinted. The name of the tint must be indicated in the order notes (see Silkstone® tints on page 58).

The location of the cut-outs for the mixer tap and the location of the sewerage hole must be indicated in the order notes.

Attention! According to an EU industry standard, not all mixer taps are suitable for placement on the edge of this bathtub. It is possible to install mixer taps if the side width of the surface is not less than 120 mm.



DECO CORNER A, 1600x1270

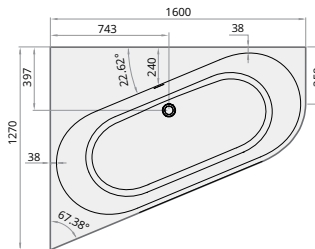

DECO CORNER D, 1600x1270

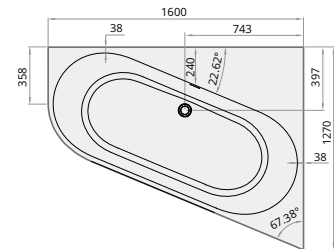

DECO CORNER A, 1600x1270



DECO SHAPE
Made to Measure
1660-2500 × 725-1275 mm
h = 630 mm
Volume: 240 l
Weight: 130 kg
Integrated push-open drain-overflow (included)

Bath in Silkstone®, 1660-1800 × 725-850 mm*	3950	4650	VADESHM/xx
Bath in Silkstone®, 1660-2500 × 725-1275 mm*	4700	5400	VADESHL/xx

* The surface of the DECO SHAPE bathtub is made to the exact measurements and shape provided by the client, therefore a drawing of the bathtub must be included in the order (see page 54).

Corner roundings, cuttings and cut-outs are included in the price.

Only the surface of a bathtub is tinted (see Silkstone® tints on page 58).

Not all bathtub sizes have a tinted surface (should be agreed upon).

Cut-outs for the mixer tap and sewer connection are included in the price.

It is possible to install mixer taps if the side width of the surface is not less than 120 mm.

The minimum surface area around the bathtub is shown in the drawing below.

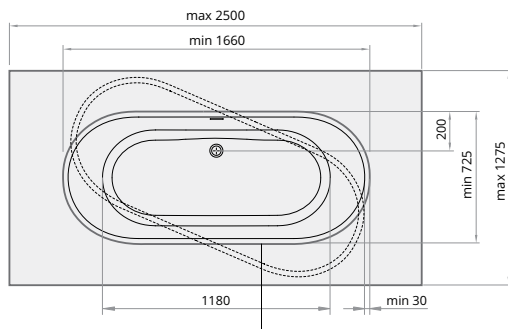

minimum surface around the tub

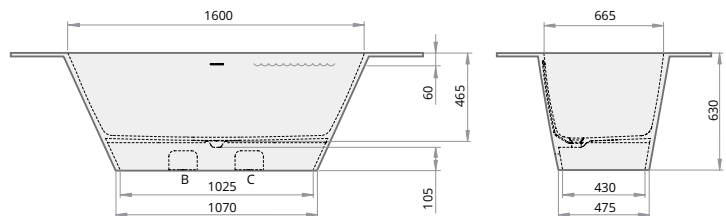

Item	Description	Price EUR		Art. NR.
		White	In colour	White / In colour



DECO SHAPE RE, 1700-2000x825

DECO SHAPE RE

1700-2000 × 825 mm
h = 630 mm
Volume: 240 l
Weight: 110 kg
Integrated push-open
drain-overflow (included)

Bath in Silkstone®, 1700-2000 × 825 mm*

3950

4650

VADESHRE/xx

* The surface length of the DECO SHAPE RE bathtub is adjusted according to the measurements provided by the client, therefore, when placing an order, it is mandatory to attach a drawing that indicates the length of the bathtub and the location of the mixer tap cut-outs with their measurements, if necessary (see page 54).
Only the surface of a bathtub is tinted. The name of the tint must be indicated in the order notes (see Silkstone® tints on page 58).
Cut-outs for the mixer tap and sewer connection are included in the price, their location must be indicated in the drawing.

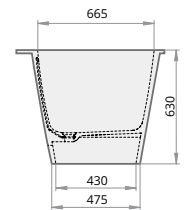
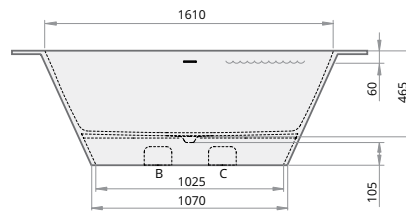
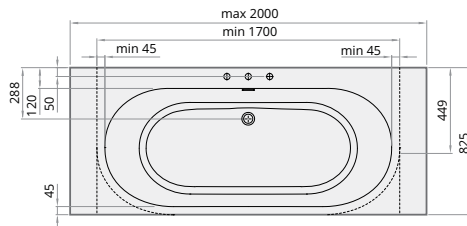

DECO SHAPE RE A, 1700-2000x825

DECO SHAPE RE A

1700-2000 × 825 mm
h = 630 mm
Volume: 240 l
Weight: 112 kg
Integrated push-open
drain-overflow (included)

Bath in Silkstone®, 1700-2000 × 825 mm*

3950

4650

VADESHAREA/xx

* The surface length of the DECO SHAPE RE A bathtub is adjusted according to the measurements provided by the client, therefore, when placing an order, it is mandatory to attach a drawing that indicates the length of the bathtub and the location of the mixer tap cut-outs with their measurements, if necessary (see page 54).
Only the surface of a bathtub is tinted. The name of the tint must be indicated in the order notes (see Silkstone® tints on page 58).
Cut-outs for the mixer tap and sewer connection are included in the price, their location must be indicated in the drawing.

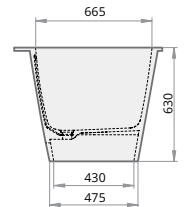
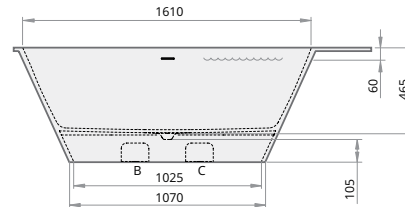
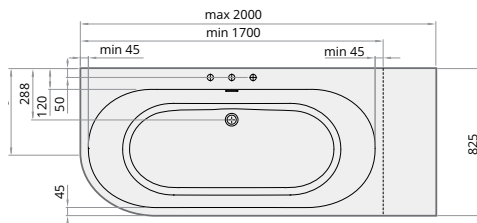

DECO SHAPE RE D, 1700-2000x825

DECO SHAPE RE D

1700-2000 × 825 mm
h = 630 mm
Volume: 240 l
Weight: 112 kg
Integrated push-open
drain-overflow (included)

Bath in Silkstone®, 1700-2000 × 825 mm*

3950

4650

VADESHRED/xx

* The surface length of the DECO SHAPE RE D bathtub is adjusted according to the measurements provided by the client, therefore, when placing an order, it is mandatory to attach a drawing that indicates the length of the bathtub and the location of the mixer tap cut-outs with their measurements, if necessary (see page 54).
Only the surface of a bathtub is tinted. The name of the tint must be indicated in the order notes (see Silkstone® tints on page 58).
Cut-outs for the mixer tap and sewer connection are included in the price, their location must be indicated in the drawing.

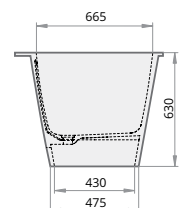
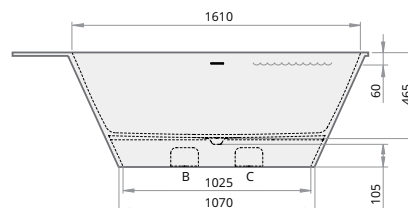
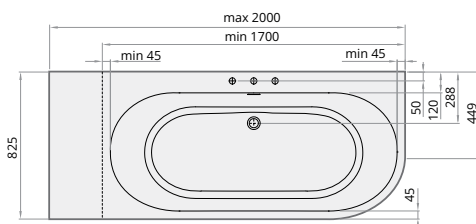

Item	Description	Price EUR		Art. NR.
		White	In colour	White / In colour



QUADRO
 1590 x 700 mm
 h = 610 mm
 Volume: 275 l
 Weight: 104/115 kg
 Integrated push-open
 drain-overflow
 (included)

Bath in Cast Stone	2550	3550	VAQUA/xx
Bath in Silkstone®	3300	3800	VAQUAS/xx
Bath in GRAPHITE		4450	VAQUAS/01

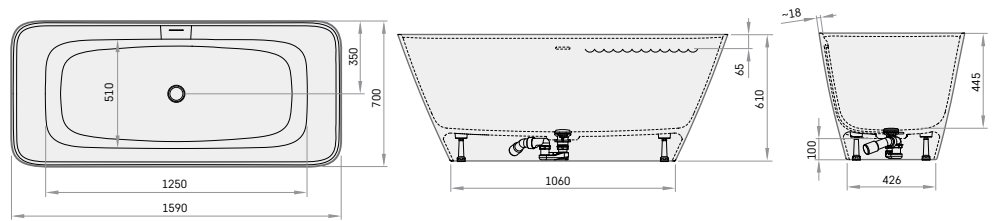

**QUADRO
 CORNER A/D**
 1600 x 750 mm
 h = 600 mm
 Volume: 250 l
 Weight: 108/136 kg
 Integrated push-open
 drain-overflow
 (included)

Bath in Cast Stone	2550	3550	VAQUACOA/xx, VAQUACOD/xx
Bath in Silkstone®	3300	3800	VAQUACOSA/xx, VAQUACOSD/xx
Bath in GRAPHITE		4450	VAQUACOSA/01, VAQUACOSD/01

Optional:

Cut-outs for mixer taps	100	RURBSS / RURBPB
-------------------------	-----	-----------------

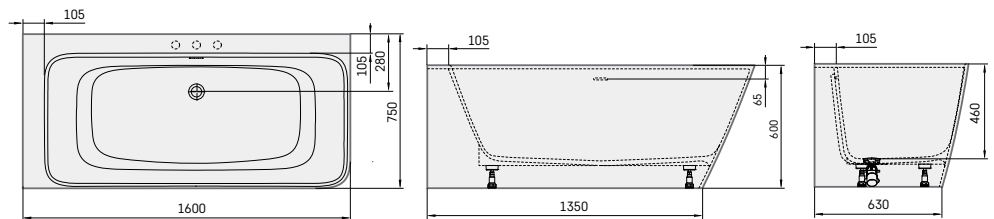

QUADRO WALL
 1605 x 760 mm
 h = 600 mm
 Volume: 275 l
 Weight: 108/136 kg
 Integrated push-open
 drain-overflow
 (included)

Bath in Cast Stone	2550	3550	VAQUAWA/xx
Bath in Silkstone®	3300	3800	VAQUAWAS/xx
Bath in GRAPHITE		4450	VAQUAWAS/01

Optional:

Cut-outs for mixer taps	100	RURBSS / RURBPB
-------------------------	-----	-----------------

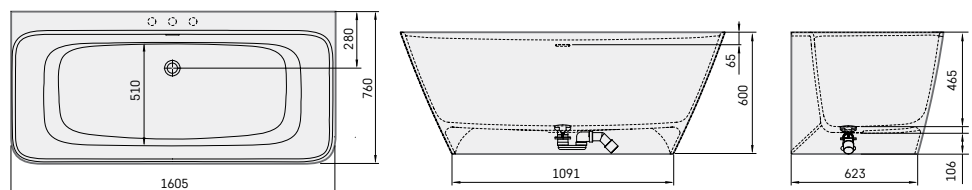



VARIO M
 1600 × 750 mm
 1500-1600 × 750 mm
 h = 565 mm
 Volume: 200 l
 Weight: 100 kg

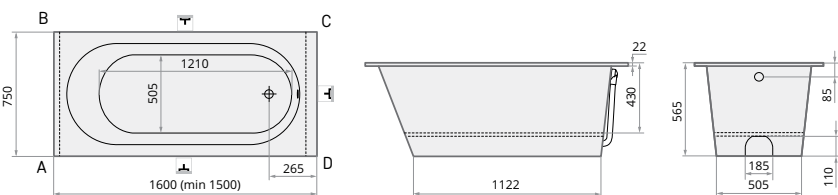

* For a standard drain-overflow bathtub (Art.NO. SIFVPA80/xx) the minimum length is 1510 mm

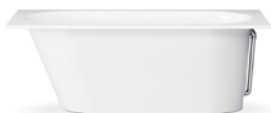

VARIO L
 1700 × 750 mm
 1600-1700 × 750 mm
 h = 625 mm
 Volume: 220 l
 Weight: 107 kg

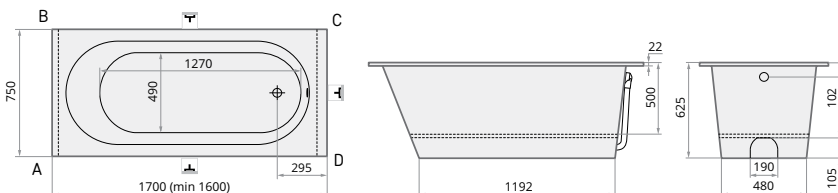

* For a standard drain-overflow bathtub (Art.NO. SIFVPA80/xx) the minimum length is 1610 mm



VARIO XL
 1850 × 800 mm
 1750-1850 × 800 mm
 h = 635 mm
 Volume: 240 l
 Weight: 135 kg

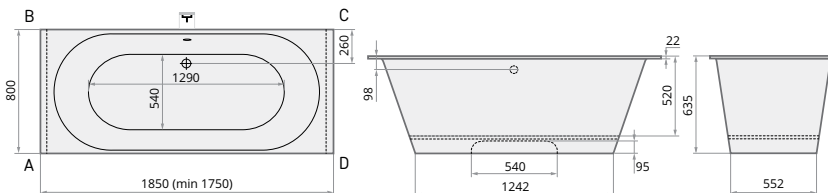

Item	Description	Price EUR		Art. NR.
		White	In colour	

Vario collection rectangular bathtub



Bath in Cast Stone, VARIO M 1600 × 750 *	1200	1550	VAVARM/xx
Bath in Cast Stone, VARIO L 1700 × 750 *	1340	1710	VAVARL/xx
Bath in Cast Stone, VARIO XL 1850 × 800	1650	1940	VAVARXL/xx
Shortening the bathtub length to min. (see drawing)	130		RVSA

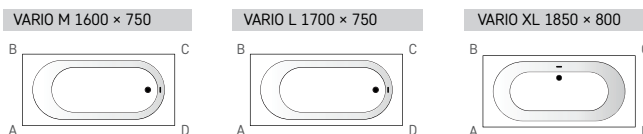

Vario collection free-standing bathtubs



Bath in Cast Stone, VARIO M 1560 × 750 mm ABCD	1720	2080	VAVARMABCD/xx
Bath in Cast Stone, VARIO L 1660 × 750 mm ABCD	1800	2150	VAVARLABCD/xx
Bath in Cast Stone, VARIO XL 1750 × 800 mm ABCD	2240	2450	VAVARXLABCD/xx

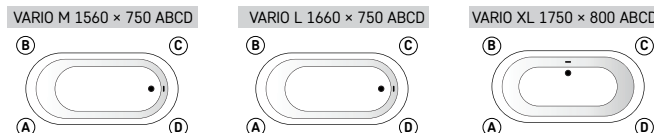

Vario collection bathtub components:

Drain-overflow chromed plastic* (Vario M, L, XL)	110	SIFVPA80/00
Drain-overflow black metal plastic* (Vario M, L, XL)	210	SIFVPA80/01
Drain-overflow in metal, chrome colour (Vario M)	200	SIFVARM/H
Drain-overflow in metal, chrome colour (Vario L)	200	SIFVARL/H
Drain-overflow in metal, chrome colour (Vario XL)	310	SIFVBELM/H

Item	Description	Price EUR		Art. NR. White / In colour
		White	In colour	
Vario collection bathtubs with 1 rounded corner	Bath in Cast Stone, VARIO M 1580 × 750 A *	1330	1680	VAVARMA/xx
	Bath in Cast Stone, VARIO M 1580 × 750 B *	1330	1680	VAVARMB/xx
	Bath in Cast Stone, VARIO M 1580 × 750 C *	1330	1680	VAVARMC/xx
	Bath in Cast Stone, VARIO M 1580 × 750 D *	1330	1680	VAVARMD/xx
	Bath in Cast Stone, VARIO L 1680 × 750 A **	1480	1970	VAVARLA/xx
	Bath in Cast Stone, VARIO L 1680 × 750 B **	1480	1970	VAVARLB/xx
	Bath in Cast Stone, VARIO L 1680 × 750 C **	1480	1970	VAVARLC/xx
	Bath in Cast Stone, VARIO L 1680 × 750 D **	1480	1970	VAVARLD/xx
	Bath in Cast Stone, VARIO XL 1800 × 800 A	1800	2070	VAVARXLA/xx
	Bath in Cast Stone, VARIO XL 1800 × 800 D	1800	2070	VAVARXLD/xx
	Shortening the bathtub length to min. (see drawing)	130		RVSA

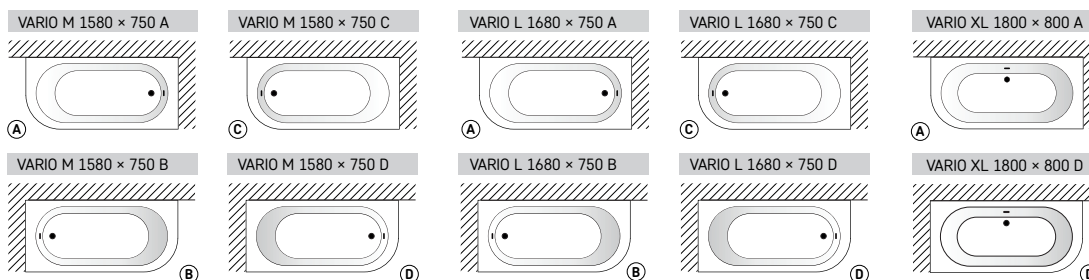

Vario collection bathtubs with 2 rounded corners



Bath in Cast Stone, VARIO M 1560 × 750 AD	1450	1820	VAVARMAD/xx
Bath in Cast Stone, VARIO M 1560 × 750 BC	1450	1820	VAVARMB/xx
Bath in Cast Stone, VARIO L 1660 × 750 AD	1610	1970	VAVARLAD/xx
Bath in Cast Stone, VARIO L 1660 × 750 BC	1610	1970	VAVARLBC/xx
Bath in Cast Stone, VARIO XL 1755 × 800 AD	1920	2190	VAVARXLAB/xx

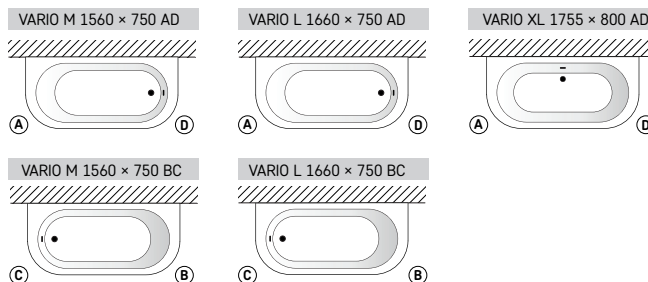

Vario collection bathtubs with 2 rounded corners at the end



Bath in Cast Stone, VARIO M 1580 × 750 AB	1450	1820	VAVARMAB/xx
Bath in Cast Stone, VARIO L 1680 × 750 AB	1610	1970	VAVARLAB/xx
Bath in Cast Stone, VARIO XL 1800 × 800 AB	1920	2190	VAVARXLAB/xx
Bath in Cast Stone, VARIO XL 1800 × 800 CD	1920	2190	VAVARXLCD/xx

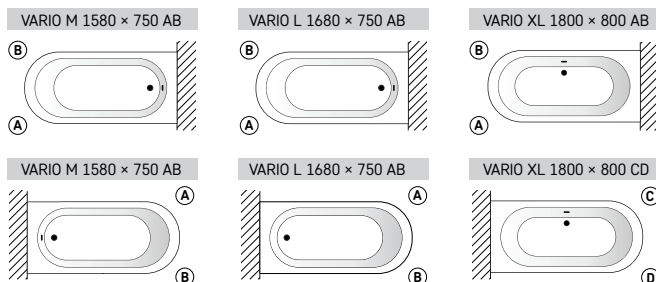

All prices in EUR

Item	Description	Price EUR		Art. NR.
		White	In colour	



UNO 150
 1500 × 750 mm
 h = 640 mm
 Volume: 210 l
 Weight: 83 kg

Bath in Cast Stone	950	1340	VAUNO/xx
Front panel, small	100	160	PAUNOM/xx
Drain-overflow chromed plastic	110	110	SIFVPA80/00
TOTAL	1160	1610	
Optional:			
Drain-overflow in metal, chrome colour		200	SIFVUNO/H

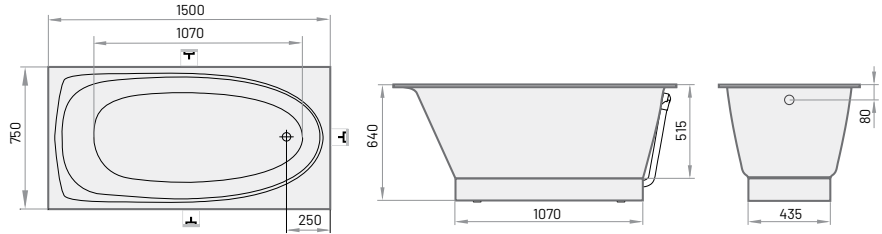

UNO 170
 1700 × 750 mm
 h = 640 mm
 Volume: 240 l
 Weight: 90 kg

Bath in Cast Stone	1040	1410	VAUNOGR/xx
Front panel, small	110	160	PAUNOGRM/xx
Drain-overflow chromed plastic	110	110	SIFVPA80/00
TOTAL	1260	1680	
Optional:			
Drain-overflow in metal, chrome colour		200	SIFVUNO/H

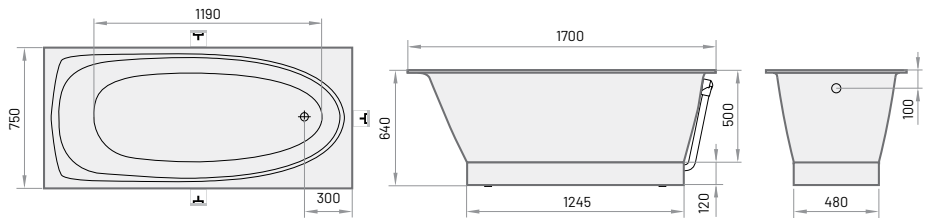

TRE 150 A/D
 1500 × 1000 mm
 h = 640 mm
 Volume: 240 l
 Weight: 88 kg

Bath in Cast Stone (left/right side)	1030	1400	VATRE/A/xx; VATRE/D/xx
Front panel, small	110	160	PATREM/xx
Drain-overflow chromed plastic	110	110	SIFVPA80/00
TOTAL	1250	1670	

Optional:			
Front panel, high (left/right side)	230		PATREA/A/00; PATREA/D/00



A (Left side)



D (Right side)

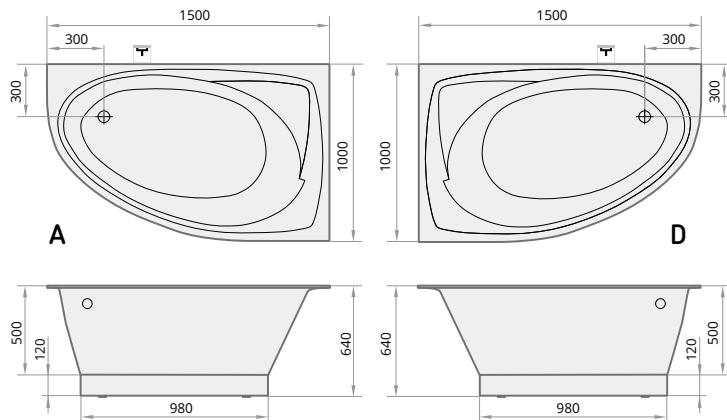

Item	Description	Price EUR		Art. NR.
		White	In colour	White / In colour
TRE 170 A/D 1700 × 1000 mm h = 650 mm Volume: 270 l Weight: 102 kg	Bath in Cast Stone (left/right side)	1140	1510	VATREGRA/A/xx; VATREGRA/D/xx
	Front panel, small	110	140	PATREGRM/xx
	Drain-overflow chromed plastic	110	110	SIFVPAA80/00
	TOTAL	1360	1760	
	Optional:			
	Front panel, high (left/right side)	230		PATREGRA/A/00; PATREGRA/D/00



A (Left side)



D (Right side)

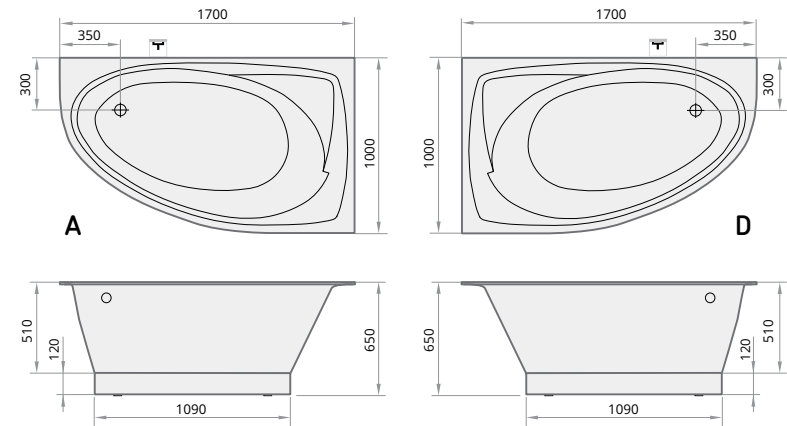

VERSO BATHS

VERSO 1700 × 750 mm h = 640 mm Volume: 225 l Weight: 72 kg	Verso rectangular bath with panel	1280	1650	VAVER/xx
	Verso A - bath with rounded corner and panel	1410	1780	VAVERA/xx
	Verso D - bath with rounded corner and panel	1410	1780	VAVERD/xx
	Verso AD - bath with 2 rounded corners and panel	1540	1920	VAVERAD/xx
	Optional:			
	Drain-overflow chromed plastic	110		SIFVPAA80/00



A



D



AD

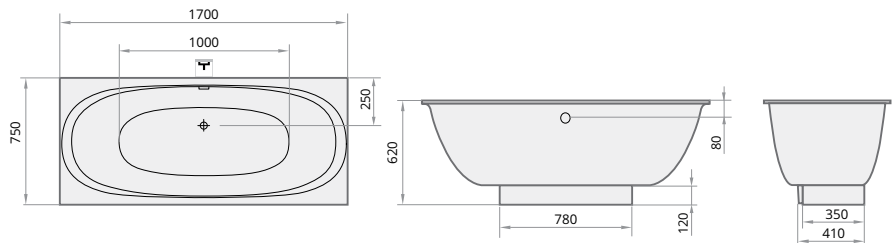

Optional:				
	Drain-overflow black metal plastic (UNO 150, UNO 170, TRE 150 A/D, TRE 170 A/D, VERSO)	210		SIFVPAA80/01

Example with OPUS MINI basin



OPUS MINI 600 x 420 x 100
 OPUS MINI basin,
 H = 100 mm, integrated brackets
 Price € 780

Price table for OPUS MINI basins

Surface edges height (H), mm	Length of surface (L), mm										Non-standard sizes & shapes
	450-550	551-800	801-1000	1001-1200	1201-1400	1401-1600	1601-1800	1801-2000	2001-2200		
H = 25, white, 1 basin	580	640	730	780	860	930	1000	1070	1140		Upon request
H = 30-100, white, 1 basin	670	780	860	940	1010	1080	1170	1240	1330		
H = 110-150, white, 1 basin	770	880	970	1070	1140	1240	1330	1410	1510		
Optional:											
2nd basin*	290										Upon request
Backwall rim, h = 30 mm (always in surface tone)	160										
Wall panel, h = 60 - 200 mm	Matte White	90	130	140	170	200	210	240	300	310	
	tinted	100	140	170	200	210	280	300	310	360	
	GRAPHITE	130	160	190	230	270	300	340	380	430	
Wall panel, h = 201 - 400 mm	Matte White	170	210	300	340	410	460	500	570	630	
	tinted	200	270	310	380	460	530	580	670	730	
	GRAPHITE	230	300	380	460	540	600	680	770	840	
Towel holder (per unit)**	90										
Rounding (only, if H = 25) or cutting of a corner	90										
Countertop in colour (basin is always white)	190	200	210	230	240	290	310	330	360		
Additional bracket, 400 mm, white (per unit)***	60										
Preparation of drawings / 2D / 3D before product manufacture****	70										
Outline milling on the surface (1 pcs.)	60										
Push-open drain with chromed or Silkstone® cover	100										
Permanent open drain with chromed or Silkstone® cover	90										

- * 2nd basin is available, if the length of countertop (L) is equal to or more than: 900 mm;
- ** Towel holder is available, if the height of panel (H) is at least 100 mm and surface length (L) more than: 450 mm;
- *** Standard mounts are included. Additional brackets must be ordered if: the load capacity of the wall is not sufficient or the H value of the surface is less than 100 mm. It is recommended to use 1 bracket for every 900 mm of surface length (L). Brackets are not required if the washbasin is placed on furniture;
- **** Technical advice on drawing processing, surface assembly and drawing coordination.

The order must be accompanied by a completed Order form for *Made to Measure* washbasins (see page 27).

There may be slight differences in the shade of white colour for basins and the rest of countertop elements. See Silkstone® product tints on page 58.

Tolerated error of dimensions for basin position and dimensions in the surface +/-5 mm.

Sizes of OPUS MINI washbasins

OPUS MINI
 305 x 265 mm

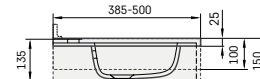
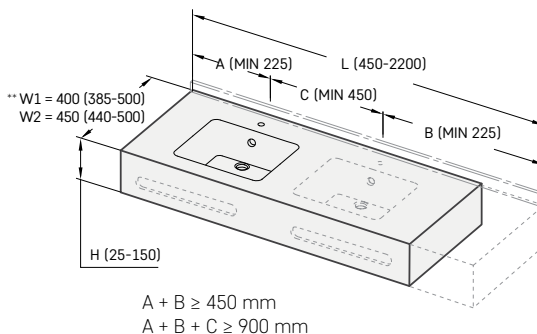
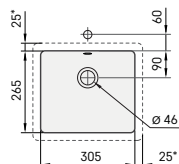

*the outer perimeter of the washbasin

The distance from the cut-out for the mixer tap to the wall is min 55mm

**W1 = (min-max) size when the mixer from the wall
 W2 = (min-max) size when the mixer is placed on the surface of the sink.

Examples with OPUS basin



OPUS 1200 × 450 × 100
 OPUS basin,
 H = 100 mm, cut corner,
 integrated brackets
 Price € 1030 (940 + 90)



OPUS DUO 1200 × 450 × 150
 2 OPUS basins,
 H = 150 mm, towel holder,
 backwall rim, integrated brackets
 Price € 1610 (1070 + 290 + 90 + 160)

Price table for OPUS basins

Surface edges height (H), mm	Length of surface (L), mm								Non-standard sizes & shapes		
	600-800	801-1000	1001-1200	1201-1400	1401-1600	1601-1800	1801-2000	2001-2200			
H = 25, white, 1 basin	640	730	780	860	930	1000	1070	1140	Upon request		
H = 30-100, white, 1 basin	780	860	940	1010	1080	1170	1240	1330			
H = 110-150, white, 1 basin	880	970	1070	1140	1240	1330	1410	1510			
Optional:											
2nd basin*									290	Upon request	
Backwall rim, h = 30 mm (always in surface tone)									160		
Wall panel, h = 60 - 200 mm	Matte White	h = 60	130	140	170	200	210	240	300		310
		tinted	140	170	200	210	280	300	310		360
		GRAPHITE	160	190	230	270	300	340	380		430
Wall panel, h = 201 - 400 mm	Matte White	h = 201	210	300	340	410	460	500	570		630
		tinted	270	310	380	460	530	580	670		730
		GRAPHITE	300	380	460	540	600	680	770		840
Towel holder (per unit)**									90		
Rounding (only, if H = 25) or cutting of a corner									90		
Countertop in colour (basin is always white)	200	210	230	240	290	310	330	360			
Additional bracket, 400 mm, white (per unit)***									60		
Preparation of drawings / 2D / 3D before product manufacture****									70		
Outline milling on the surface (1 pcs.)									60		
Push-open drain with chromed or Silkstone® cover									100		
Permanent open drain with chromed or Silkstone® cover									90		

- * 2nd basin is available, if the length of countertop (L) is equal to or more than 1200 mm;
- ** The towel holder is available if the height of the surface edge (H) is 100 mm and the distance from the side edge of the washbasin to the centre of the basin (A, B ≥ 350 mm);
- *** Standard mounts are included. Additional brackets must be ordered if: the load capacity of the wall is not sufficient or the H value of the surface is less than 100 mm. It is recommended to use 1 bracket for every 900 mm of surface length (L). Brackets are not required if the washbasin is placed on furniture;
- **** Technical advice on drawing processing, surface assembly and drawing coordination.

The order must be accompanied by a completed Order form for *Made to Measure* washbasins (see page 27).
 There may be slight differences in the shade of white colour for basins and the rest of countertop elements. See Silkstone® product tints on page 58.
 Tolerated error of dimensions for basin position and dimensions in the surface +/-5 mm.

Sizes of OPUS washbasins

OPUS

470 × 270 mm
 Front side integrated overflow

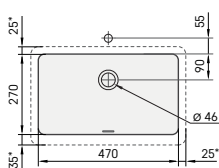

*the outer perimeter of the washbasin

The distance from the cut-out for the mixer tap to the wall is min 55mm

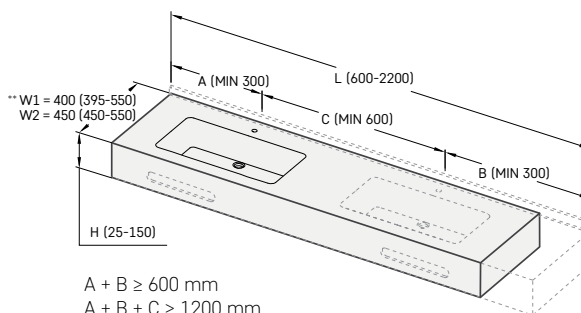

$A + B \geq 600 \text{ mm}$
 $A + B + C \geq 1200 \text{ mm}$

**W1 = (min-max) size when the mixer from the wall
 W2 = (min-max) size when the mixer is placed on the surface of the sink.

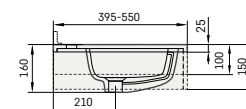

Additional brackets (400 mm)

Examples with OPUS GRANDE basins



OPUS GRANDE 1200 × 500 × 100
OPUS GRANDE basin,
H = 100 mm, integrated brackets
Price € 1010



OPUS GRANDE 1450 × 550 × 150
2 OPUS GRANDE basins,
H = 150 mm, backwall rim,
towel holder, integrated brackets
Price € 1920 (1310 + 330 + 190 + 90)

Price table for OPUS GRANDE basins

Surface edges height (H), mm	Length of surface (L), mm								Non-standard sizes & shapes	
	700-800	801-1000	1001-1200	1201-1400	1401-1600	1601-1800	1801-2000	2001-2200		
H = 25, white, 1 basin	760	840	910	1000	1070	1140	1210	1310	Upon request	
H = 30-100, white, 1 basin	830	910	1010	1070	1150	1240	1330	1430		
H = 110-150, white, 1 basin	940	1040	1130	1230	1310	1410	1500	1620		
Optional:										
2nd basin*	330								Upon request	
Backwall rim, h = 30 mm (always in surface tone)	160									
Wall panel, h = 60 - 200 mm	Matte White	130	140	170	200	210	240	300		310
	tinted	140	170	200	210	280	300	310		360
	GRAPHITE	160	190	230	270	300	340	380		430
Wall panel, h = 201 - 400 mm	Matte White	210	300	340	410	460	500	570		630
	tinted	270	310	380	460	530	580	670		730
	GRAPHITE	300	380	460	540	600	680	770		840
Towel holder (per unit)**	90									
Rounding (only, if H = 25) or cutting of a corner	90									
Countertop in colour (basin is always white)	200	210	230	240	290	310	330	360		
Additional bracket, 480 mm, white (per unit)***	60									
Preparation of drawings / 2D / 3D before product manufacture****	70									
Outline milling on the surface (1 pcs.)	60									
Push-open drain with chromed or Silkstone® cover	100									
Permanent open drain with chromed or Silkstone® cover	90									

* 2nd basin is available, if the length of countertop (L) is equal to or more than 1400 mm;

** Towel holder is available, if the height of panel (H) is at least 100 mm and surface length (L) more than: 700 mm;

*** Standard mounts are included. Additional brackets must be ordered if: the load capacity of the wall is not sufficient or the H value of the surface is less than 100 mm It is recommended to use 1 bracket for every 900 mm of surface length (L). Brackets are not required if the washbasin is placed on furniture;

**** Technical advice on drawing processing, surface assembly and drawing coordination.

The order must be accompanied by a completed Order form for *Made to Measure* washbasins (see page 27).

There may be slight differences in the shade of white colour for basins and the rest of countertop elements. See Silkstone® product tints on page 58.

Tolerated error of dimensions for basin position and dimensions in the surface +/-5 mm.

Sizes of OPUS GRANDE washbasins

OPUS GRANDE

600 × 334 mm

Front side integrated overflow

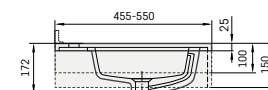
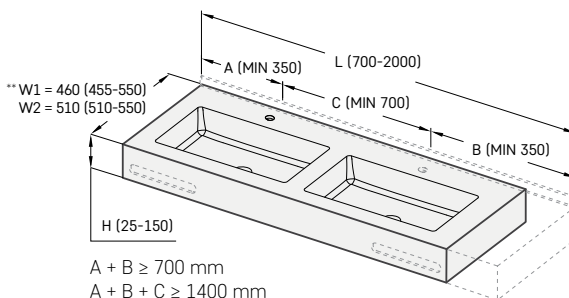
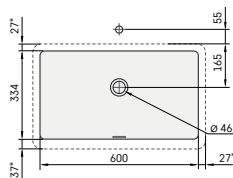

Additional brackets (480 mm)

*the outer perimeter of the washbasin

The distance from the cut-out for the mixer tap to the wall is min 55mm.

**W1 = (min-max) size when the mixer from the wall
W2 = (min-max) size when the mixer is placed on the surface of the sink.

Examples with STRETTO basins



STRETTO 550 × 300 × 150
STRETTO basin,
H = 150 mm, integrated brackets
Price € 710



STRETTO DUO 1200 × 300 × 150
2 STRETTO basins,
H = 150 mm, integrated brackets
Price € 1320 (1030 + 290)

Price table for STRETTO basins

Surface edges height (H), mm	Lenght of surface (L), mm										Non-standard sizes & shapes		
	500-550	551-800	801-1000	1001-1200	1201-1400	1401-1600	1601-1800	1801-2000	2001-2200				
H = 150, white, 1 basin	710	800	910	1030	1070	1170	1270	1340	1480		Upon request		
Optional:													
2nd basin*											290	Upon request	
Backwall rim, h = 30 mm (always in surface tone)											160		
Wall panel, h = 60 - 200 mm	Matte White	90	130	140	170	200	210	240	300	310			
		tinted	100	140	170	200	210	280	300	310	360		
		GRAPHITE	130	160	190	230	270	300	340	380	430		
Wall panel, h = 201 - 400 mm	Matte White	170	210	300	340	410	460	500	570	630			
		tinted	200	270	310	380	460	530	580	670	730		
		GRAPHITE	230	300	380	460	540	600	680	770	840		
Towel holder (per unit)**											90		
Rounding (only, if H = 25) or cutting of a corner											90		
Countertop in colour (basin is always white)	190	200	210	230	240	290	310	330	360				
Preparation of drawings / 2D / 3D before product manufacture***											70		
Outline milling on the surface (1 pcs.)											60		
Permanent open drain with chromed or Silkstone® cover											90		

- * 2nd basin is available, if the length of countertop (L) is equal to or more than 1050 mm;
- ** Towel holder is available, if the height of panel (H) is at least 100 mm and surface length (L) more than: 500 mm;
- *** Technical advice on drawing processing, surface assembly and drawing coordination.

Integrated brackets are included in completion.

The order must be accompanied by a completed Order form for *Made to Measure* washbasins (see page 27).

There may be slight differences in the shade of white colour for basins and the rest of countertop elements. See Silkstone® product tints on page 58.

Tolerated error of dimensions for basin position and dimensions in the surface +/-5 mm.

Sizes of STRETTO washbasins

STRETTO

378 × 180 mm
Washbasin without overflow
Overflow is available in additional ordered.



Mixer tap on the sides

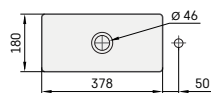

Mixer tap in the centre

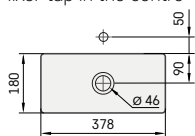

The distance from the cut-out for the mixer tap to the wall is min 55mm.

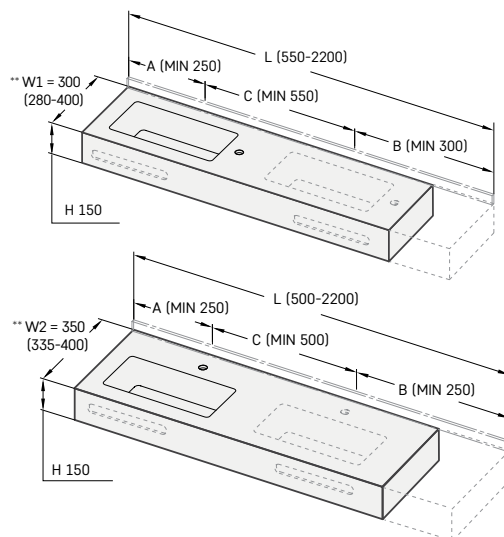

**W1 = (min-max) size when the mixer from the wall
W2 = (min-max) size when the mixer is placed on the surface of the sink.

Minimal length (L) of countertop STRETTO, mixer tap on basin side:
1 basin: A + B ≥ 550 mm
2 basins: A + B + C ≥ 1100 mm

Minimal length (L) of countertop STRETTO, without mixer tap:
1 basin: A + B ≥ 500 mm
2 basins: A + B + C ≥ 1000 mm

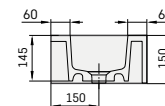

Minimal length (L) of countertop STRETTO, mixer tap on basin center:
1 basin: A + B ≥ 500 mm
2 basins: A + B + C ≥ 1100 mm

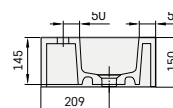

All prices in EUR

Examples with ROUND basin



ROUND 500 × 500 × 150
 ROUND basin.
 H = 150 mm, integrated brackets
 Price € 940



ROUND 1800 × 550 × 150
 3 ROUND basins, H = 150 mm,
 backwall rim, integrated brackets
 Price € 2230 (1410 + (2 × 330) + 160)

Price table for ROUND basins

Surface edges height (H), mm	Lenght of surface (L), mm								Non-standard sizes & shapes		
	500-800	801-1000	1001-1200	1201-1400	1401-1600	1601-1800	1801-2000	2001-2200			
H = 25, white, 1 basin	760	840	910	1000	1070	1140	1210	1310	Upon request		
H = 30-100, white, 1 basin	830	910	1010	1070	1150	1240	1330	1430			
H = 110-150, white, 1 basin	940	1040	1130	1230	1310	1410	1500	1620			
Optional:											
2nd basin*									330	Upon request	
Backwall rim, h = 30 mm (always in surface tone)									160		
Wall panel, h = 60 - 200 mm	Matte White	tinted	130	140	170	200	210	240	300		310
		GRAPHITE	140	170	200	210	280	300	310		360
		GRAPHITE	160	190	230	270	300	340	380		430
Wall panel, h = 201 - 400 mm	Matte White	tinted	210	300	340	410	460	500	570		630
		GRAPHITE	270	310	380	460	530	580	670		730
		GRAPHITE	300	380	460	540	600	680	770		840
Towel holder (per unit)**									90		
Rounding (only, if H = 25) or cutting of a corner									90		
Countertop in colour (basin is always white)	200	210	230	240	290	310	330	360			
Additional bracket, 400 / 480 mm, white (per unit)***									60		
Preparation of drawings / 2D / 3D before product manufacture****									70		
Outline milling on the surface (1 pcs.)									60		
Push-open drain with chromed or Silkstone® cover									100		
Permanent open drain with chromed or Silkstone® cover									90		

- * 2nd basin is available, if the length of countertop (L) is equal to or more than 1050 mm;
- ** Towel holder is available, if the height of panel (H) is at least 100 mm and surface length (L) more than: 500 mm;
- *** Standard mounts are included. Additional brackets must be ordered if: the load capacity of the wall is not sufficient or the H value of the surface is less than 100 mm It is recommended to use 1 bracket for every 900 mm of surface length (L). Brackets are not required if the washbasin is placed on furniture;
- **** Technical advice on drawing processing, surface assembly and drawing coordination.

The order must be accompanied by a completed Order form for *Made to Measure* washbasins (see page 27).
 There may be slight differences in the shade of white colour for basins and the rest of countertop elements. See Silkstone® product tints on page 58.
 Tolerated error of dimensions for basin position and dimensions in the surface +/-5 mm.

Sizes of ROUND washbasins

ROUND
 D 400 mm

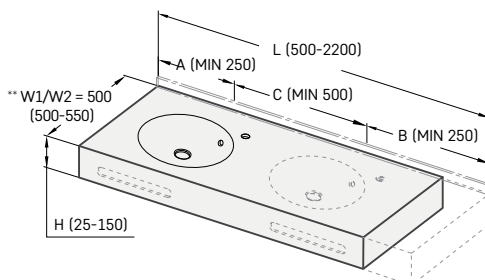
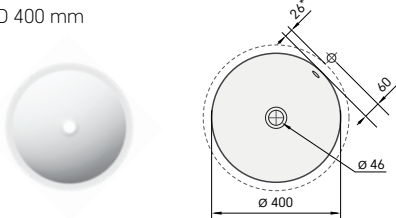

Minimal leght for ROUND basins with mixer tap cut-out 45° from center:
 A + B ≥ 500 mm
 A + B + C ≥ 1000 mm

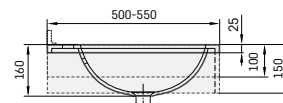
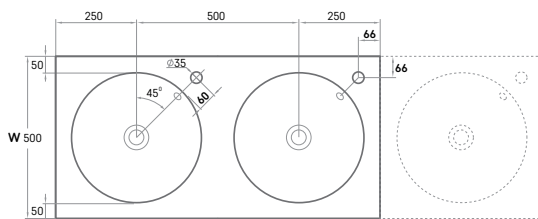

Additional brackets (480 mm)

*the outer perimeter of the washbasin
 The distance from the cut-out for the mixer tap to the wall is min 55mm.

**W1 = (min-max) size when the mixer from the wall
 W2 = (min-max) size when the mixer is placed on the surface of the sink.

Examples with OVO basins



OVO DUO 1400 × 500 × 150
 2 OVO basins, H = 150 mm,
 towel holder, backwall rim, integrated brackets
 Price € 1810 (1230 + 330 + 90 + 160)

Price table for OVO basins

Surface edges height (H), mm	Lenght of surface (L), mm								Non-standard sizes & shapes	
	650-800	801-1000	1001-1200	1201-1400	1401-1600	1601-1800	1801-2000	2001-2200		
H = 25, white, 1 basin	760	840	910	1000	1070	1140	1210	1310	Upon request	
H = 30-100, white, 1 basin	830	910	1010	1070	1150	1240	1330	1430		
H = 110-150, white, 1 basin	940	1040	1130	1230	1310	1410	1500	1620		
Optional:										
2nd basin*	330								Upon request	
Backwall rim, h = 30 mm (always in surface tone)	160									
Wall panel, h = 60 - 200 mm	Matte White	130	140	170	200	210	240	300		310
	tinted	140	170	200	210	280	300	310		360
Wall panel, h = 201 - 400 mm	GRAPHITE	160	190	230	270	300	340	380		430
	Matte White	210	300	340	410	460	500	570		630
Towel holder (per unit)**	tinted	270	310	380	460	530	580	670		730
	GRAPHITE	300	380	460	540	600	680	770		840
Rounding (only, if H = 25) or cutting of a corner	90									
Countertop in colour (basin is always white)	200	210	230	240	290	310	330	360		
Additional bracket, 400 / 480 mm, white (1 pcs.)***	60									
Preparation of drawings / 2D / 3D before product manufacture****	70									
Outline milling on the surface (1 pcs.)	60									
Push-open drain with chromed or Silkstone® cover	100									
Permanent open drain with chromed or Silkstone® cover	90									

- * 2nd basin is available, if the length of countertop (L) is equal to or more than 1250 mm;
- ** Towel holder is available, if the height of panel (H) is at least 100 mm and surface length (L) more than: 650 mm;
- *** Standard mounts are included. Additional brackets must be ordered if: the load capacity of the wall is not sufficient or the H value of the surface is less than 100 mm It is recommended to use 1 bracket for every 900 mm of surface length (L). Brackets are not required if the washbasin is placed on furniture;
- **** Technical advice on drawing processing, surface assembly and drawing coordination.

The order must be accompanied by a completed Order form for *Made to Measure* washbasins (see page 27).
 There may be slight differences in the shade of white colour for basins and the rest of countertop elements. See Silkstone® product tints on page 58.
 Tolerated error of dimensions for basin position and dimensions in the surface +/-5 mm.

Sizes of OVO washbasins

OVO
 500 × 320 mm

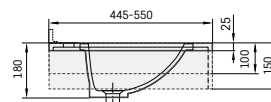
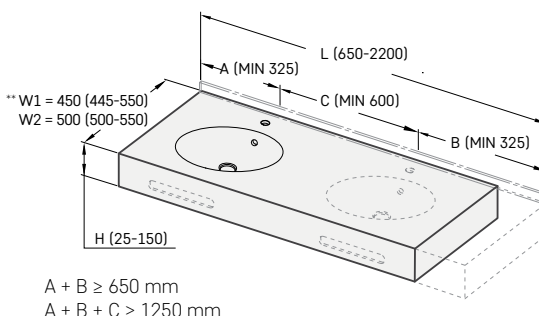
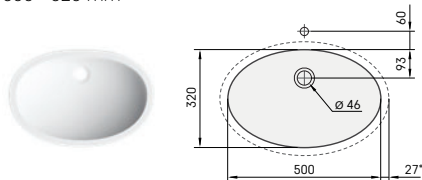

Additional brackets
 (400 mm, if W 480-499 mm)
 (480 mm, if W 500-550 mm)

*the outer perimeter of the washbasin

The distance from the cut-out for the mixer tap to the wall is min 55mm.

**W1 = (min-max) size when the mixer from the wall
 W2 = (min-max) size when the mixer is placed on the surface of the sink.

Example with PIANO basin



PIANO DUO 1600 × 600 × 150
 2 PIANO basins, panel (H = 150 mm),
 backwall rim, integrated brackets
 Price € 1940 (1440 + 340 + 160)

Price table for PIANO basins

Surface edges height (H), mm	Lenght of surface (L), mm								Non-standard sizes & shapes	
	700-800	801-1000	1001-1200	1201-1400	1401-1600	1601-1800	1801-2000	2001-2200		
H = 25, white, 1 basin	800	910	1000	1070	1150	1210	1340	1440	Upon request	
H = 30-100, white, 1 basin	880	1000	1080	1200	1270	1380	1480	1580		
H = 110-150, white, 1 basin	1030	1130	1230	1340	1440	1550	1650	1780		
Optional:										
2nd basin*	340								Upon request	
Backwall rim, h = 30 mm (always in surface tone)	160									
Wall panel, h = 60 - 200 mm	Matte White	130	140	170	200	210	240	300		310
	tinted	140	170	200	210	280	300	310		360
	GRAPHITE	160	190	230	270	300	340	380		430
Wall panel, h = 201 - 400 mm	Matte White	210	300	340	410	460	500	570		630
	tinted	270	310	380	460	530	580	670		730
	GRAPHITE	300	380	460	540	600	680	770		840
Towel holder (per unit)**	90									
Rounding (only, if H = 25) or cutting of a corner	90									
Countertop in colour (basin is always white)	200	210	230	240	290	310	330	360		
Additional bracket, 480 mm, white (per unit)***	60									
Preparation of drawings / 2D / 3D before product manufacture****	70									
Outline milling on the surface (1 pcs.)	60									
Push-open drain with chromed or Silkstone® cover	100									
Permanent open drain with chromed or Silkstone® cover	90									

- * 2nd basin is available, if the length of countertop (L) is equal to or more than 1400 mm;
- ** Towel holder is available, if the height of panel (H) is at least 100 mm and surface length (L) more than: 700 mm;
- *** Standard mounts are included. Additional brackets must be ordered if: the load capacity of the wall is not sufficient or the H value of the surface is less than 100 mm It is recommended to use 1 bracket for every 900 mm of surface length (L). Brackets are not required if the washbasin is placed on furniture;
- **** Technical advice on drawing processing, surface assembly and drawing coordination.

The order must be accompanied by a completed Order form for *Made to Measure* washbasins (see page 27).
 There may be slight differences in the shade of white colour for basins and the rest of countertop elements. See Silkstone® product tints on page 58.
 Tolerated error of dimensions for basin position and dimensions in the surface +/- 5 mm.

Sizes of PIANO washbasins

PIANO
 560 × 420 mm

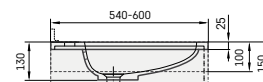
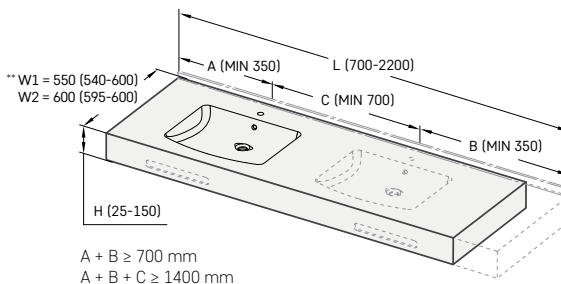
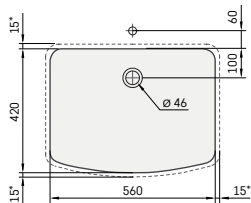

Additional brackets (480 mm)

*the outer perimeter of the washbasin
 The distance from the cut-out for the mixer tap to the wall is min 55mm

**W1 = (min-max) size when the mixer from the wall
 W2 = (min-max) size when the mixer is placed on the surface of the sink.

Example with CREDO basin



CREDO 1200 × 600 × 25
 CREDO basin, w/o panel (H = 25 mm),
 backwall rim, 3 additional brackets
 Price € 1340 (1000 + 160 + (3 × 60))

Price table for CREDO basins

Surface edges height (H), mm	Lenght of surface (L), mm								Non-standard sizes & shapes		
	600-800	801-1000	1001-1200	1201-1400	1401-1600	1601-1800	1801-2000	2001-2200			
H = 25, white, 1 basin	800	910	1000	1070	1150	1210	1340	1440	Upon request		
H = 30-100, white, 1 basin	880	1000	1080	1200	1270	1380	1480	1580			
H = 110-150, white, 1 basin	1030	1130	1230	1340	1440	1550	1650	1780			
Optional:											
2nd basin*	340								Upon request		
Backwall rim, h = 30 mm (always in surface tone)	160										
Wall panel, h = 60 - 200 mm	Matte White	130	140	170	200	210	240	300		310	
		tinted	140	170	200	210	280	300		310	360
		GRAPHITE	160	190	230	270	300	340		380	430
Wall panel, h = 201 - 400 mm	Matte White	210	300	340	410	460	500	570		630	
		tinted	270	310	380	460	530	580		670	730
		GRAPHITE	300	380	460	540	600	680		770	840
Towel holder (per unit)**	90										
Rounding (only, if H = 25) or cutting of a corner	90										
Countertop in colour (basin is always white)	200	210	230	240	290	310	330	360			
Additional bracket, 480 mm, white (per unit)***	60										
Preparation of drawings / 2D / 3D before product manufacture****	70										
Outline milling on the surface (1 pcs.)	60										
Push-open drain with chromed or Silkstone® cover	100										
Permanent open drain with chromed or Silkstone® cover	90										

* 2nd basin is available, if the length of countertop (L) is equal to or more than 1200 mm;

** The towel holder is available if the height of the surface edge (H) is 100 mm and the distance from the side edge of the washbasin to the centre of the basin (A, B ≥ 350 mm);

*** Standard mounts are included. Additional brackets must be ordered if: the load capacity of the wall is not sufficient or the H value of the surface is less than 100 mm It is recommended to use 1 bracket for every 900 mm of surface length (L). Brackets are not required if the washbasin is placed on furniture;

**** Technical advice on drawing processing, surface assembly and drawing coordination.

The order must be accompanied by a completed Order form for *Made to Measure* washbasins (see page 27).

There may be slight differences in the shade of white colour for basins and the rest of countertop elements. See Silkstone® product tints on page 58.

Tolerated error of dimensions for basin position and dimensions in the surface +/-5 mm.

Sizes of CREDO washbasins

CREDO

475 × 430 mm
 integrated overflow

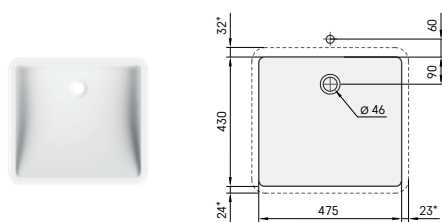

*the outer perimeter of the washbasin

The distance from the cut-out for the mixer tap to the wall is min 55mm

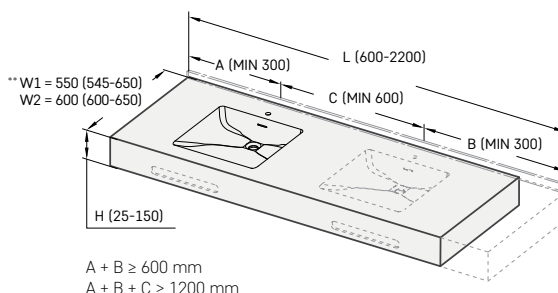

A + B ≥ 600 mm
 A + B + C ≥ 1200 mm

**W1 = (min-max) size when the mixer from the wall
 W2 = (min-max) size when the mixer is placed on the surface of the sink.

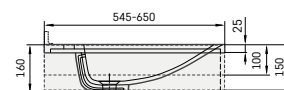

Additional brackets (480 mm)

Examples with QUADRO basins



QUADRO 1200 × 480 × 100
 QUADRO basin,
 H = 100 mm, integrated brackets
 Price € 1200

Price table for QUADRO basins

Surface edges height (H), mm	Lenght of surface (L), mm							Non-standard sizes & shapes		
	800-1000	1001-1200	1201-1400	1401-1600	1601-1800	1801-2000	2001-2200			
H = 25, white, 1 basin	1030	1110	1180	1270	1330	1450	1550	Upon request		
H = 30-100, white, 1 basin	1110	1200	1310	1380	1500	1600	1700			
H = 110-150, white, 1 basin	1240	1340	1450	1550	1670	1770	1900			
Optional:										
2nd basin*	460							Upon request		
Backwall rim, h = 30 mm (always in surface tone)	110									
Wall panel, h = 60 - 200 mm	Matte White	White	140	170	200	210	240		300	310
		tinted	170	200	210	280	300		310	360
		GRAPHITE	190	230	270	300	340		380	430
Wall panel, h = 201 - 400 mm	Matte White	White	300	340	410	460	500		570	630
		tinted	310	380	460	530	580		670	730
		GRAPHITE	380	460	540	600	680		770	840
Towel holder (per unit)**	90									
Rounding (only, if H = 25) or cutting of a corner	90									
Countertop in colour (basin is always white)	210	230	240	290	310	330	360			
Additional bracket, 480 mm, white (per unit)***	60									
Preparation of drawings / 2D / 3D before product manufacture****	70									
Outline milling on the surface (1 pcs.)	60									

- * 2nd basin is available, if the length of countertop (L) is equal to or more than 1600 mm;
- ** Towel holder is available, if the height of panel (H) is at least 100 mm and surface length (L) more than: 800 mm;
- *** Standard mounts are included. Additional brackets must be ordered if: the load capacity of the wall is not sufficient or the H value of the surface is less than 100 mm It is recommended to use 1 bracket for every 900 mm of surface length (L). Brackets are not required if the washbasin is placed on furniture;
- **** Technical advice on drawing processing, surface assembly and drawing coordination.

The order must be accompanied by a completed Order form for *Made to Measure* washbasins (see page 27).
 There may be slight differences in the shade of white colour for basins and the rest of countertop elements. See Silkstone® product tints on page 58.
 Tolerated error of dimensions for basin position and dimensions in the surface +/- 5 mm.

Sizes of QUADRO washbasins

QUADRO
 680 × 290mm

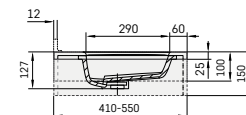
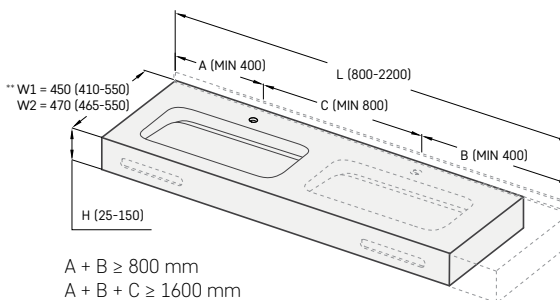
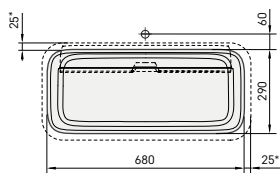

*the outer perimeter of the washbasin

The distance from the cut-out for the mixer tap to the wall is min 55mm

**W1 = (min-max) size when the mixer from the wall
 W2 = (min-max) size when the mixer is placed on the surface of the sink.

Order form for MADE TO MEASURE washbasins

1. Choose your basin (mark your choice):

Take into account the requirements of each basin regards the length (L), width (W), and height (H) of countertop!



OPUS MINI 300 x 265 mm
 *W1 = 400 (385-500) mm
 W2 = 450 (440-500) mm
 WM = min. 60 mm; WW = 265 mm
 WB = min. 60 mm
 L = 450-2200; H = 25-150 mm
 A + B ≥ 450 mm
 A + B + C ≥ 900 mm
 On Furniture:
 W1 = min. 385; W2 = min. 440 mm



OPUS 470 x 270 mm
 *W1 = 400 (395-550) mm
 W2 = 450 (450-550) mm
 WM = min. 55 mm; WW = 270 mm
 WB = min. 70 mm
 L = 600-2200; H = 25-150 mm
 A + B ≥ 600 mm
 A + B + C ≥ 1200 mm
 On Furniture:
 W1 = min. 395; W2 = min. 450



OPUS GRANDE 600 x 334 mm
 *W1 = 460 (455-550) mm
 W2 = 510 (510-550) mm
 WM = min. 55 mm; WW = 334 mm
 WB = min. 70 mm
 L = 700-2200; H = 25-150 mm
 A + B ≥ 700 mm
 A + B + C ≥ 1400 mm
 On Furniture:
 W1 = min. 455; W2 = min. 510

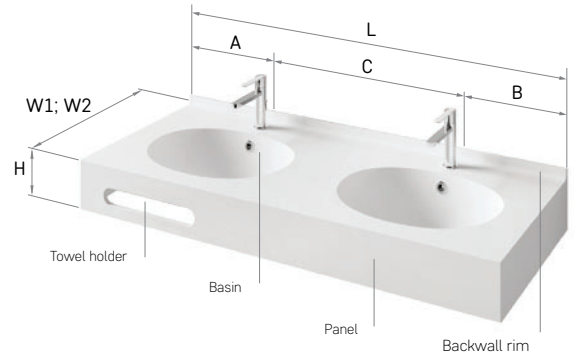

OVO 500 x 320 mm
 *W1 = 450 (445-550) mm
 W2 = 500 (500-550) mm
 WM = min. 60 mm; WW = 320 mm
 WB = min. 65 mm
 L = 650-2200; H = 25-150 mm
 A + B ≥ 450 mm
 A + B + C ≥ 1250 mm
 On Furniture:
 W1 = min. 445; W2 = min. 500 mm



CREDO 475 x 430 mm
 *W1 = 550 (545-650) mm
 W2 = 600 (600-650) mm
 WM = min. 60 mm; WW = 430 mm
 WB = min. 55 mm
 L = 600-2200; H = 25-150 mm
 A + B ≥ 600 mm
 A + B + C ≥ 1200 mm
 On Furniture:
 W1 = min. 545; W2 = min. 600 mm



PIANO 560 x 420 mm
 *W1 = 550 (540-600) mm
 W2 = 600 (595-600) mm
 WM = min. 60 mm; WW = 420 mm
 WB = min. 60 mm
 L = 700-2200; H = 25-150 mm
 A + B ≥ 700 mm
 A + B + C ≥ 1400 mm
 On Furniture:
 W1 = min. 540; W2 = min. 595 mm



STRETTO 378 x 180 mm
 *W1 = 300 (280-400) mm
 W2 = 350 (335-400) mm
 WM = min. 50; WW = 180 mm
 WB = min. 60 / 50 mm
 L = 550/500-2200; H = 150 mm
 A + B ≥ 550/600 mm
 A + B + C ≥ 1100 / 1000 mm
 On Furniture:
 W1 = min. 280; W2 = min. 335 mm



ROUND D 400 mm
 *W1 = 500 (500-550) mm
 W2 = 500 (500-550) mm
 WM = min. 60; WW = 400 mm
 WB = min. 50 mm
 L = 500-2200; H = 25-150 mm
 A + B ≥ 500 mm
 A + B + C ≥ 1000 mm
 On Furniture:
 W1 & W2 = min. 500 mm

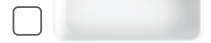

QUADRO 680 x 290 mm
 *W1 = 450 (410-550) mm
 W2 = 470 (465-550) mm
 WM = min. 60; WW = 290 mm
 WB = 60 mm
 L = 800-2200; H = 25-150 mm
 A + B ≥ 800 mm
 A + B + C ≥ 1600 mm
 On Furniture:
 W1 = min. 410; W2 = min. 465 mm
 No overflow available

* W1 = Recommended (min-max) size when the mixer from the wall

W2 = Recommended (min-max) size when the mixer is placed on the surface of the sink. Marginal deviations of the internal size of the sink and its positioning on the surface +/-5mm.

2. Mark the number of basins you need / write down the key measures of your countertop / mark if you need Towel holder (300 x 35 mm)** fully mark ▽ to show panel location:

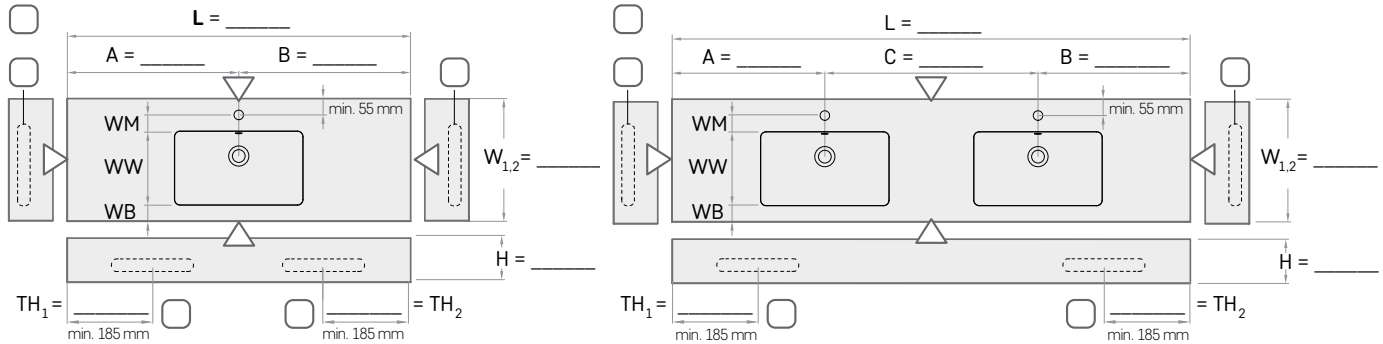

**Towel holders TH1, TH2 are available only if the height of the panel (H) is at least 100 mm and the possible position is defined by the manufacturer.

3. Mark the type of mixer tap placement (drilling at no additional cost)***

MIXER TAP ON COUNTERTOP SURFACE

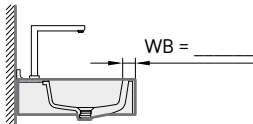

MIXER TAP FROM WALL

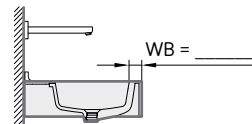

5. Mark if you need integrated backwall rim and wall panel, backwall rim and wall panel (thickness = 12 mm) and length equal to surface length (L):

backwall rim (h = 30mm) wall panel h = _____ mm NO

6. Mark if you want tinted countertop & tinted wall panel (Specify a tint name):

MATTE WHITE TINTED _____ (bowel available only in MATTE WHITE)

7. Mark if brackets are needed (see recommended number of brackets below)**:

1 pc. 2 pcs. NO
 3 pcs. (L ≥ 1200 mm) 4 pcs. (L ≥ 1600 mm) integrated brackets (H ≥ 100 mm), included in the price

8. Mark if it is necessary: rounding of the corner(s) of the surface (possible only if the edge height is 25 mm), cutting, milling or drilling:

Rounding*** Milling*** Cutting*** NO

9. Mark if overflow is needed (included in the price):

YES NO
 If NO is not checked, overflow will be made for all washbasins except Quadro.

4. Mark the basin position:

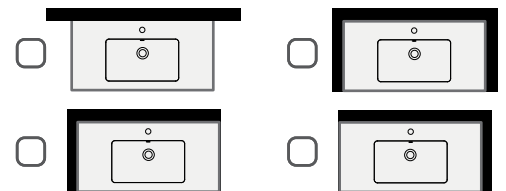

Countertop on furniture

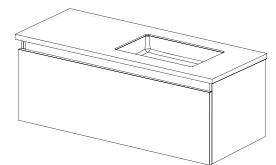

10. Mark drain type:

- Permanent open with Silkstone® cover (DEIZSNOP/00)
- Permanent open with chrome colour cover (L2264)
- Push-open with Silkstone® cover (DEIZCLICK/00) (only for basins with overflow)
- Push-open with chrome cover (L32UM) (only for basins with overflow)



*** IMPORTANT! It is required that all the items of the form are filled in and a drawing is included with the order, specifying the position of the basins, the cut-outs for installing the mixer taps, any rounded corners and cuts, as well as any non-standard solutions: i.e. bevelled surfaces, cutouts, unusually narrow surfaces without cut-outs for installing the mixer taps (wall-mounted mixer taps) etc. If the WB value is not specified in 3., then the dimensions specified in the standard drawings are used for the location of the sink and faucet (see 1.). The integrated brackets are included in the price and are only available if H is greater than 100 mm. The metal mounting brackets must be ordered for an additional fee if the load capacity of the wall is not sufficient or if the H value of the surface is less than 100 mm, not required if the washbasin is placed on furniture.

Prices of FLOW washbasins

FLOW 45

600-3000 × 450 mm
h = 160 mm

Colour – Matte White

Mixer taps can only be mounted on the wall

Brackets - integrated

Surface edges height (H), mm	Length of surface (L), mm					Non-standard sizes & shapes
	600-1000	1001-1500	1501-2000	2001-2500	2501-3000	
FLOW 45, H = 160, Silkstone®* (IFLOW450/00)	1770	2470	3180	3880	4590	Upon request

* The integrated mount and drain position is specified individually

Optional:

Backwall rim, h = 30 mm (integrated)		110	140	160	170	200	Upon request
Wall panel, h = 60 - 200 mm (separately)	Matte White	140	210	300	360	430	
	tinted	170	270	310	410	470	
	GRAPHITE	190	300	380	470	570	
Wall panel, h = 201 - 400 mm (separately)	Matte White	300	460	570	670	770	
	tinted	310	530	670	770	880	
	GRAPHITE	380	600	770	910	1040	

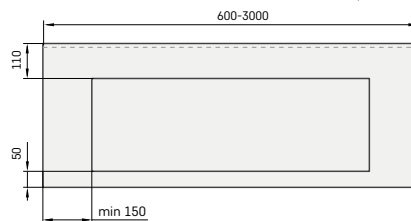
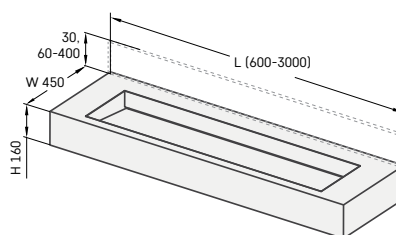
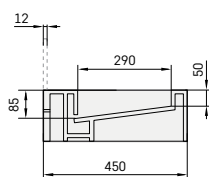

FLOW 50

600-3000 × 500 mm
h = 160 mm

Colour – Matte White

Mixer taps can be mounted on the surface or on the wall

Brackets - integrated

Surface edges height (H), mm	Length of surface (L), mm					Non-standard sizes & shapes
	600-1000	1001-1500	1501-2000	2001-2500	2501-3000	
FLOW 50, H = 160, Silkstone®* (IFLOW500/00)	1950	2650	3360	4060	4760	Upon request

* The amount and position of mixers, drain, and the integrated mount is specified individually

Optional:

Backwall rim, h = 30 mm (integrated)		110	140	160	170	200	Upon request
Wall panel, h = 60 - 200 mm (separately)	Matte White	140	210	300	360	430	
	tinted	170	270	310	410	470	
	GRAPHITE	190	300	380	470	570	
Wall panel, h = 201 - 400 mm (separately)	Matte White	300	460	570	670	770	
	tinted	310	530	670	770	880	
	GRAPHITE	380	600	770	910	1040	

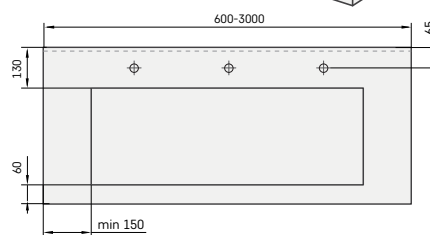
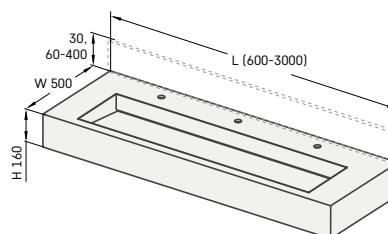
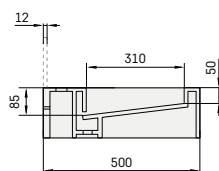

Order form for washbasins FLOW 45/50

1. Choose your basin (mark your choice):

Take into account the requirements of each basin regards the length (L), width (W) of countertop!

- | | |
|----------------------------------|----------------------------------|
| <input type="checkbox"/> FLOW 45 | <input type="checkbox"/> FLOW 50 |
| W = 450 mm | W = 500 mm |
| W1 = 50 mm | W1 = 60 mm |
| W2 = 110 mm | W2 = 130 mm |
| L = 600-3000 mm | L = 600-3000 mm |
| H = 160 mm | H = 160 mm |
| A + B ≥ 300 mm | A + B ≥ 300 mm |
| A + B + C ≥ 600 mm | A + B + C ≥ 600 mm |

WARNING! Mixer tap holes are not available for the FLOW 45 basin.
Tolerated error of dimensions for basin position and dimensions in the surface +/- 5 mm.

2. Write down the key measures of washbasin:

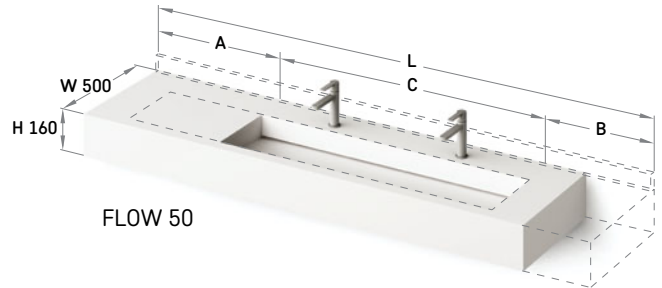
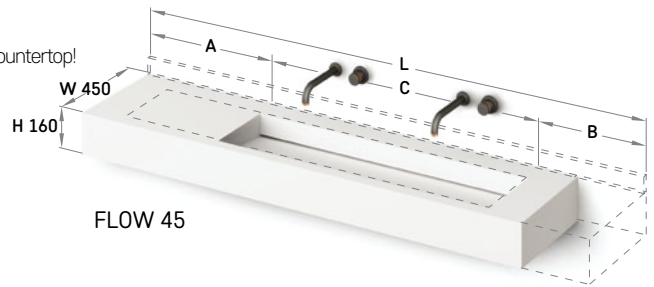
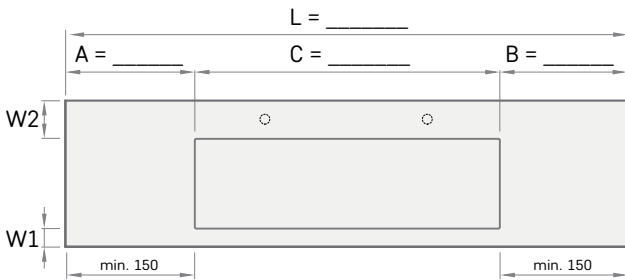

3. Does the sink will have a mixer from the wall or mixer will be located on the basin surface? Specify the location and number of tap holes:

- mixer from wall mixer on the basin surface (only FLOW 50)

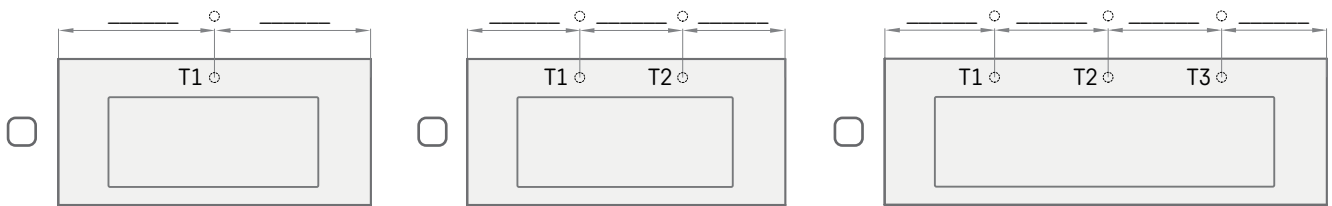

4. Indicate the location and number of syphon holes:

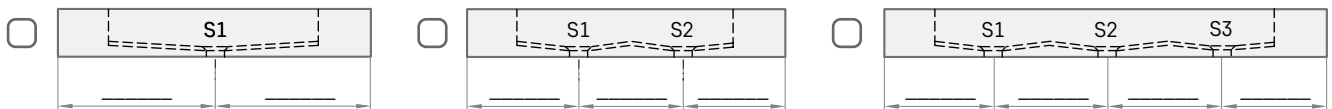

5. Mark if you need integrated backwall rim and wall panel, backwall rim and wall panel (thickness = 12 mm) and length equal to surface length (L):

- backwall rim (h = 30 mm) wall panel h = _____ mm NO

7. Mark if it is necessary milling (for example, cut for waste bin, soap dispenser, etc.)

- Milling** NO

6. Mark the basin position:

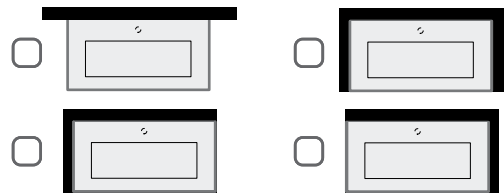

8. Comments:

**** IMPORTANT!** It is required that all the items of the form are filled in and a drawing is included with the order: the position of the basins, the locations of the holes for the installation of mixer taps, if necessary, and the location and number of syphon connection. Washbasins don't have overflow. Milling on the surface requires a drawing. Integrated mounts are included in the price.

MADE TO MEASURE CAST STONE WASHBASINS

Examples



OPUS 1200 × 450 × 25
 Set of: Irregularly shaped surface, 1 washbasin OPUS, H = 25 mm, 2 brackets (400 mm), push-open drain with chromed cover.
 Price € 1290 (910 + 160 + 120 + 100)



OVO 1300 × 535 × 25 on the locker.
 Set of: Irregularly shaped surface with rounded corners, 1 washbasin OVO, H = 25 mm, overflow, permanent open drain with chromed cover.
 Price € 1210 (950 + 160 + 100)

Price table for Made to Measure Cast Stone washbasins

Surface with 1 basin (H=25), mm	Length of surface (L), mm*							Non-standard sizes & shapes
	500-800	801-1000	1001-1200	1201-1400	1401-1600	1601-1800	1801-2000	
W = min. - 500								
Glossy Alpine White basin and surface	780	840	910	950	1020	1080	1140	Unpon request
Basin and surface in colour (see options on page 57)	940	1010	1080	1150	1230	1300	1370	
W = 501 - 600								
Glossy Alpine White basin and surface	930	980	1040	1110	1180	1250	1330	Unpon request
Basin and surface in colour (see options on page 57)	1100	1170	1250	1340	1430	1500	1580	
Second basin**								Unpon request
Irregular shape, rounding								
Bracket, 400 / 480 mm, white (1 pc.)***								
Preparation of drawings / 2D / 3D before product manufacture****								
Push-open drain with chromed or Cast Stone cover (White/In colour)								
Permanent open drain with chromed or Cast Stone cover (White/In colour)								

- * Surface min. length L depends on the type of basin selected, L min. = 500 mm (ROUND), 900 mm (OPUS), 650 mm (OVO), 700 mm (LONG STEP).
- ** The second basin is only possible if the surface length (L) is not less than 1050 mm (ROUND), 1200 mm (OPUS), 1250 mm (OVO), 1400 mm (LONG STEP).
- *** Size of brackets depends on choice of basin (400 / 480), brackets are not required if the washbasin is placed on furniture.
- **** Technical advice on drawing processing, surface assembly and drawing coordination..

The order must be accompanied by a completed Order form for Made to Measure Cast Stone washbasins (see page 32).
 There may be slight differences in the shade of white colour for basins and the rest of countertop. See Cast Stone product colours on page 57.
 Tolerated error of dimensions for basin position and dimensions in the surface +/-5 mm.

Sizes of OPUS washbasins

OPUS
 470 × 270 mm

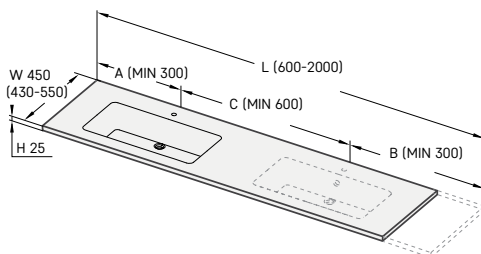
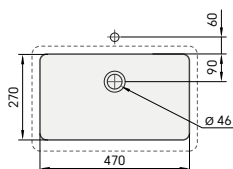

$A + B \geq 600 \text{ mm}$
 $A + B + C \geq 1200 \text{ mm}$

The distance from the cut-out for the mixer tap to the wall is min 55mm. Overflow available on request

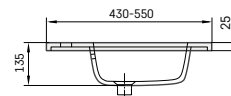

LONG STEP
540 × 335 mm

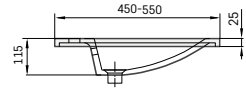
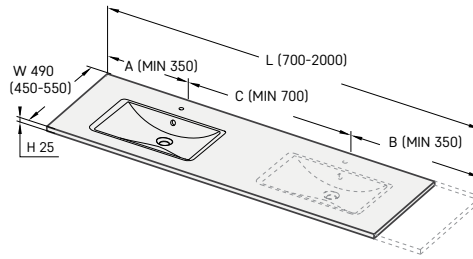
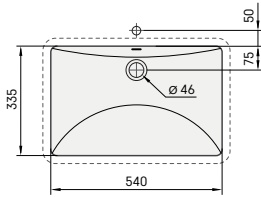

$A + B \geq 700$ mm
 $A + B + C \geq 1400$ mm
 $W_{min.} = 450$, if the surface is without cut-outs for mixer taps.

The distance from the cut-out for the mixer tap to the wall is min 55mm. Overflow available on request



ROUND
D 420 mm

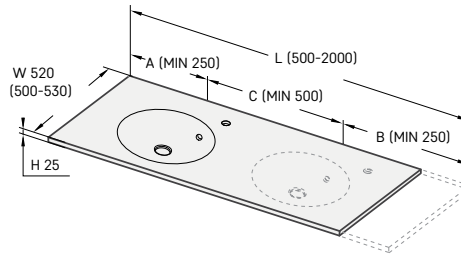
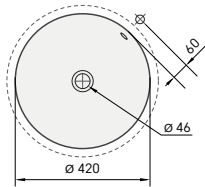

Minimum length for ROUND washbasins with cut-outs for mixer taps. 45° to the right of the center of the washbasin:

$A + B \geq 500$ mm
 $A + B + C \geq 1000$ mm

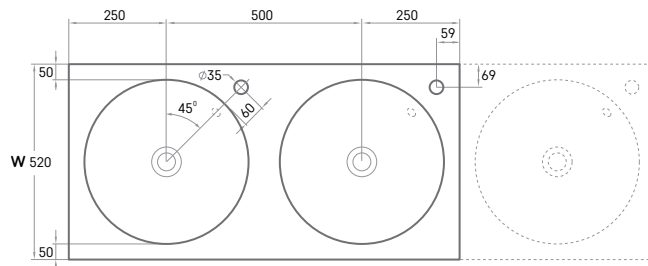
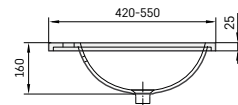

OVO
510 × 320 mm

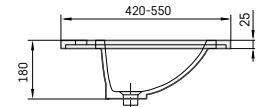
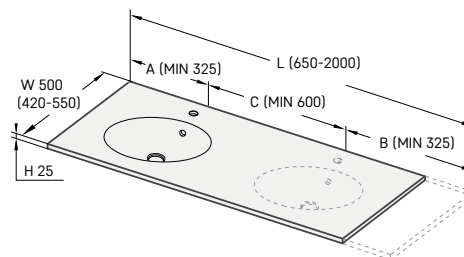
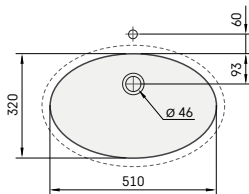

$A + B \geq 650$ mm
 $A + B + C \geq 1250$ mm
 $W_{min.} = 420$, if the surface is without cut-outs for mixer taps.

The distance from the cut-out for the mixer tap to the wall is min 55mm. Overflow available on request



Order form for MADE TO MEASURE Cast Stone washbasins

1. Choose your basin (mark your choice):

Take into account the requirements of each basin regards the length (L), width (W) of countertop!



- OVO 510 x 320 mm**
W = 500 (420-550) mm
L = 650-2000 mm
H = 25 mm
A + B ≥ 650 mm
A + B + C ≥ 1250 mm
WM & WB = min. 60 mm; WB = min. 60 mm



- LONG STEP 540 x 335 mm**
W = 500 (450-550) mm
L = 700-2000 mm
H = 25 mm
A + B ≥ 700 mm
A + B + C ≥ 1400 mm
WM & WB = min. 55 mm



- ROUND D 420 mm**
W = 520 (500-550) mm
L = 500-2000 mm
H = 25 mm
A + B ≥ 500 mm
A + B + C ≥ 1000 mm
WM & WB = min. 60 mm; WB = min. 50 mm



- OPUS 470 x 270 mm**
W = 450 (430-550) mm
L = 600-2000 mm
H = 25 mm
A + B ≥ 600 mm
A + B + C ≥ 1200 mm
WM & WB = min. 60 mm

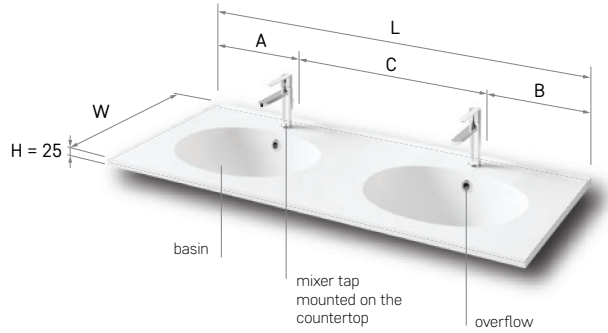

Tolerated error of dimensions for basin position and dimensions in the surface +/- 5 mm.

2. Mark the number of basins you need / write down the key measures of your countertop:

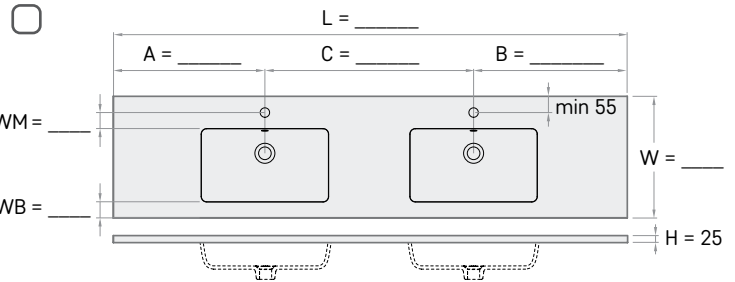
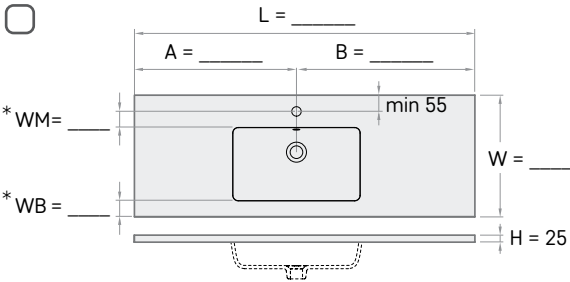

3. Mark if brackets are needed

(see recommended number of brackets below)*:

- 1 pc.
- 2 pcs.
- NO
- 3 pcs. (L ≥ 1200 mm)
- 4 pcs. (L ≥ 1600 mm)

5. Mark if you want countertop and basin in colour (specify a colour name):

- GLOSSY WHITE BASIN AND COUNTERTOP
- BASIN AND COUNTERTOP IN COLOUR (colors on page 57.). _____

6. Mark the type of mixer tap placement

(drilling at no additional cost):

- MIXER TAP ON COUNTERTOP*
- MIXER TAP ON THE WALL

7. Mark if you want irregular shape of countertop or roundings:

- Irregular shape*
- Roundings*
- NO

9. Mark if overflow is needed (no additional cost):

If NO is not checked, an overflow will be made for all sinks

- YES
- NO

10. Comments:

4. Mark the basin position:

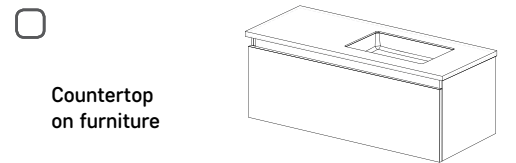
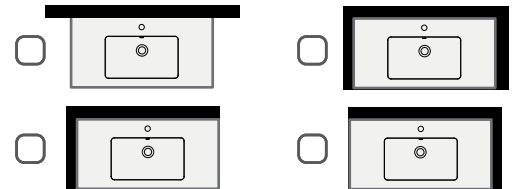

8. Mark the drain type:

- Permanent open with chromed cover (L2264)
- Permanent open drain with Cast Stone cover (DKIZPBNOP/xx)
- Push-open with chromed cover (L32UM) (only for washbasins with overflow)
- Push-open with Cast Stone cover (DEIZPBCLICK/xx) (only for washbasins with overflow)



* **IMPORTANT!** It is required that all the items of the form are filled in and a drawing is included with the order, specifying the position of the basins, the cut-outs for installing the mixer taps, any rounded corners, as well as any non-standard solutions: unusually narrow surfaces without cut-outs for installing the mixer taps (wall-mounted mixer taps) etc. If the WM&WB value is not specified in point 2, then the dimensions specified in the standard drawings are used for the location of the sink and faucet (see point 1). The metal mounting brackets are not required if the washbasin is placed on furniture.

Examples with Made to Measure Silkstone® surface and ON-TOP washbasin Amore



Silkstone® surface (h= 100 mm) with ON-TOP washbasins Amore



Silkstone® surface (h= 25 mm) with ON-TOP washbasin Amore On furniture

Prices of Made to Measure surfaces and ON-TOP washbasins

Surface width (W), mm	Surface edges height (H), mm	Lenght of surface (L), mm								Non-standard sizes & shapes
		430-800	801-1000	1001-1200	1201-1400	1401-1600	1601-1800	1801-2000	2001-2200	
W = max. 400	H = 18 / 25	300	340	400	460	500	570	630	670	Upon request
	H = 30-100	410	480	540	610	670	740	810	880	
	H = 110-150	480	560	640	710	780	870	940	1030	
W = 401-500	H = 18 / 25	340	410	470	540	600	670	740	810	Upon request
	H = 30-100	460	540	630	710	780	870	950	1040	
	H = 110-150	540	640	730	830	910	1010	1080	1170	
W = 501-600	H = 18 / 25	410	510	580	680	770	860	950	1050	Upon request
	H = 30-100	480	570	680	780	870	950	1040	1210	
	H = 110-150	600	710	830	910	1010	1080	1170	1280	

Optional:

AMORE (Matte White / TINTED / GRAPHITE) - 1 pcs.		570/760/860								Upon request
BELLA (Mate White / TINTED / GRAPHITE) - 1 pcs.		610/780/900								
DECO (Mate White / TINTED / GRAPHITE) - 1 pcs.		480/640/760								
ROUND ON (Matte White / TINTED / GRAPHITE) - 1 pcs.		380/530/630								
FELICE (Matte White / TINTED / GRAPHITE) - 1 pcs.		540/660/770								
Backwall rim, h = 30 mm (always in surface tone)		160								
Wall panel, h = 60 - 200 mm	Matte White	130	140	170	200	210	240	300	310	
	tinted	140	170	200	210	280	300	310	360	
	GRAPHITE	160	190	230	270	300	340	380	430	
Wall panel, h = 201 - 400 mm	Matte White	210	300	340	410	460	500	570	630	
	tinted	270	310	380	460	530	580	670	730	
	GRAPHITE	300	380	460	540	600	680	770	840	
Towel holder (per unit)*		90								
Rounding (only, if H = 18 / 25) or cutting of a corner		90								
Preparation of drawings / 2D / 3D before product manufacture**		70								
Cut-outs in the surface, if ordered without PAA washbasin (1 pcs.)		30								
Outline milling on the surface if ordered without PAA washbasin (1 pcs.)		90								
Tinted surface (see Silkstone® tints on page 58).		200	210	230	240	290	310	330	360	
GRAPHITE		240	270	290	300	310	340	370	380	
Additional bracket, 300/400/480 mm, white (1 pcs.)***		60								

* Towel holder is available, if the height of panel (H) is at least 100 mm and surface length (L) more than: 350 mm;

** Technical advice on drawing processing, surface assembly and drawing coordination with other manufacturers of washbasins;

*** Standard mounts are included. Additional brackets must be ordered if: the load capacity of the wall is not sufficient or the H value of the surface is less than 100 mm It is recommended to use 1 bracket for every 800 mm of surface length (L). Brackets are not required if the washbasin is placed on furniture;

The order must be accompanied by a completed Order form for *Made to Measure* surfaces and ON-TOP washbasins on the surface (see page 37).

The colour of the finished surface and the washbasin may differ slightly. See Silkstone® product tints on page 58.

Sizes of ON-TOP washbasin AMORE

AMORE
600 × 370 mm

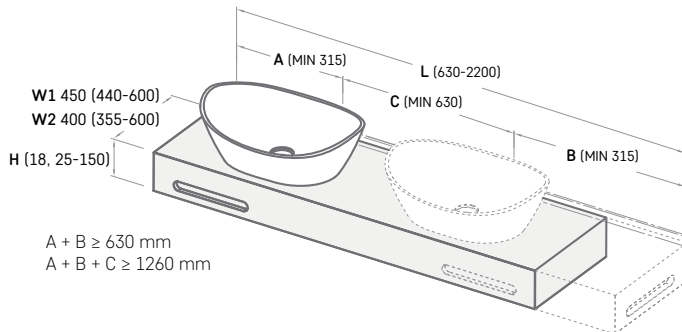

A + B ≥ 630 mm
A + B + C ≥ 1260 mm

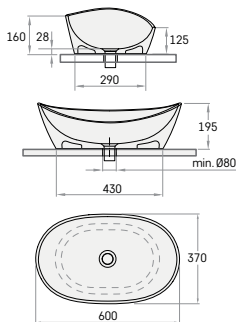

With mixer tap
on the surface

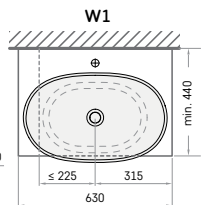

With mixer tap
from the wall

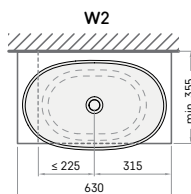
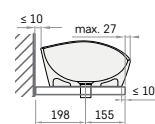

* At H = 18 mm, the surface is monolithic and only the front edge is inclined

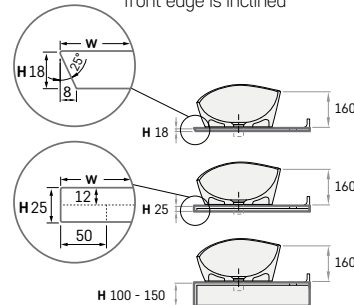

Additional brackets
(300 mm, if W 354-479 mm)
(400 mm, if W 480-499 mm)
(480 mm, if W 500-550 mm)

Sizes of ON-TOP washbasin BELLA

BELLA
650 × 390 mm

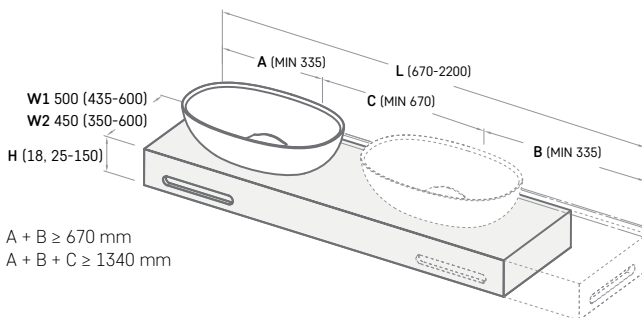

A + B ≥ 670 mm
A + B + C ≥ 1340 mm

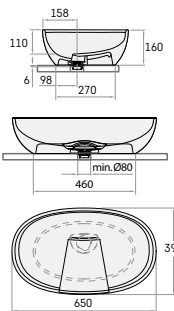

With mixer tap
on the surface

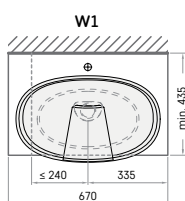

With mixer tap
from the wall

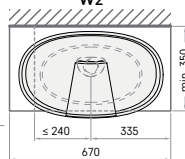
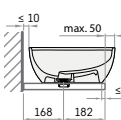

* At H = 18 mm, the surface is monolithic and only the front edge is inclined

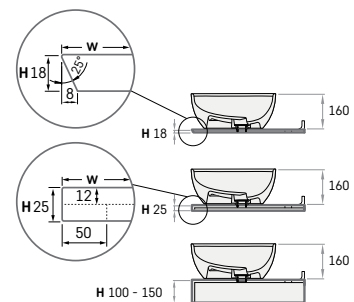

Additional brackets
(300 mm, if W 354-479 mm)
(400 mm, if W 480-499 mm)
(480 mm, if W 500-550 mm)

Sizes of ON-TOP washbasin DECO

DECO

d 450, h 122 mm

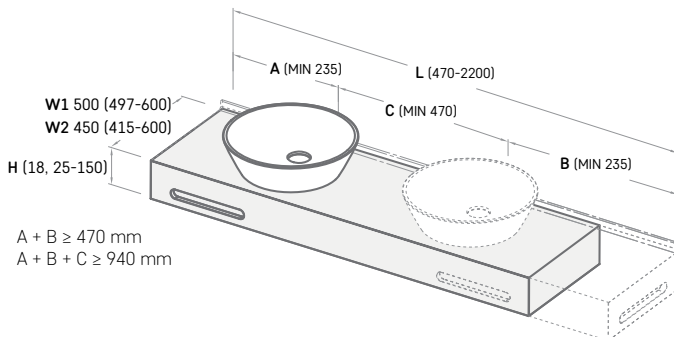

* At H = 18 mm, the surface is monolithic and only the front edge is inclined

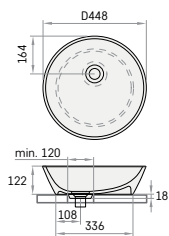
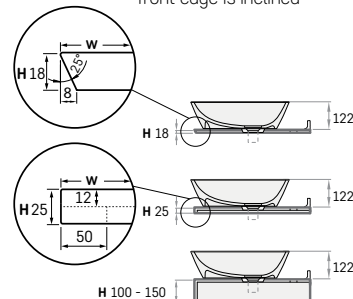

With mixer tap on the surface

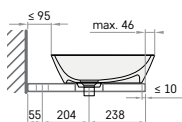

W1

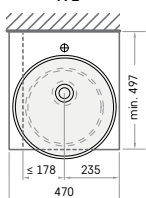

With mixer tap from the wall

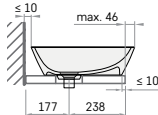

W2

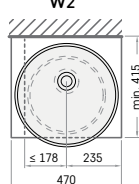

Additional brackets
(300 mm, if W 354-479 mm)
(400 mm, if W 480-499 mm)
(480 mm, if W 500-550 mm)

Sizes of ON-TOP washbasin ROUND

ROUND ON

d 410, h 140 mm

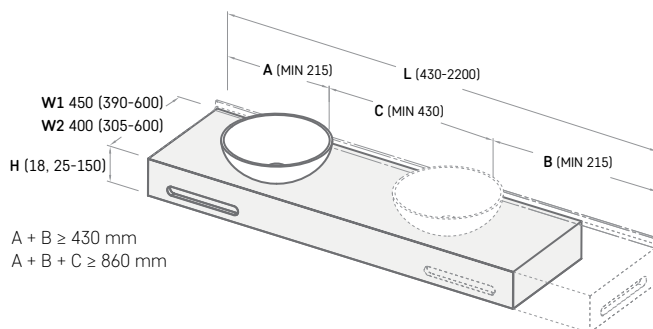

* At H = 18 mm, the surface is monolithic and only the front edge is inclined

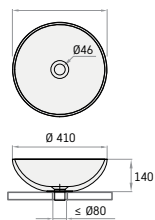
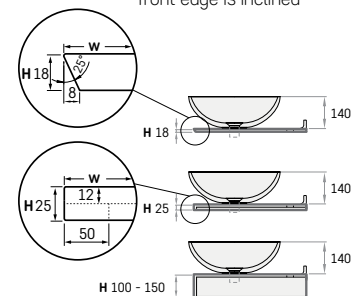

With mixer tap on the surface

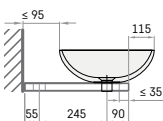

W1

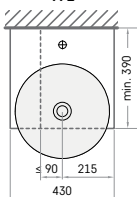

With mixer tap from the wall

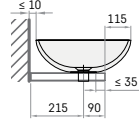

W2

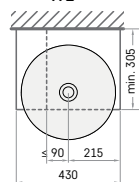

Additional brackets
(300 mm, if W 354-479 mm)
(400 mm, if W 480-499 mm)
(480 mm, if W 500-550 mm)

Sizes of ON-TOP washbasin FELICE

FELICE
690 × 375 mm

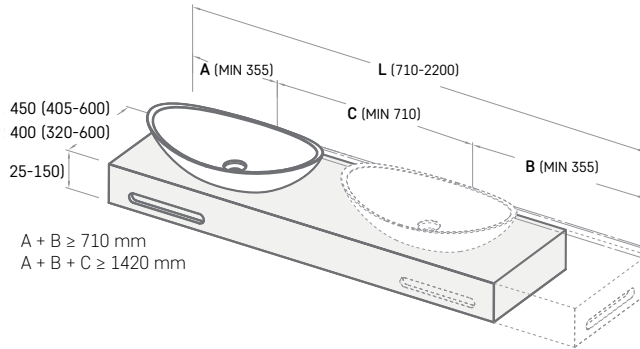

* At $H = 18 \text{ mm}$, the surface is monolithic and only the front edge is inclined

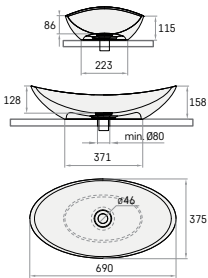
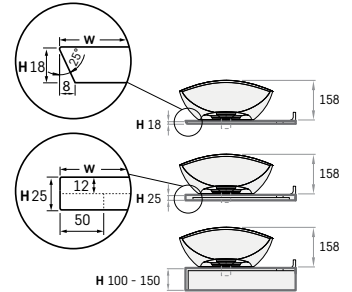

With mixer tap on the surface

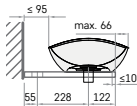

W1

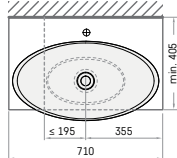

With mixer tap from the wall

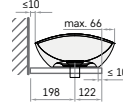

W2

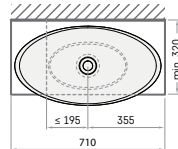

Additional brackets
 (300 mm, if W 354-479 mm)
 (400 mm, if W 480-499 mm)
 (480 mm, if W 500-550 mm)

Order form for MADE TO MEASURE surfaces and ON-TOP washbasins on the surface

1. Choose your washbasins (mark your choice)::

Take into account the requirements of each basin regards the length (L), width (W), and height (H) of countertop!



AMORE 600 × 370, h 195 mm
 W1 = 450 (440-600) mm*
 W2 = 400 (355-600) mm*
 WS = 228; WF = 155 mm
 L = 630-2200 mm
 H = 18, 25-150 mm
 A + B ≥ 630 mm
 A + B + C ≥ 1260 mm



BELLA 650 × 390, h 160 mm
 W1 = 450 (435-600) mm*
 W2 = 450 (350-600) mm*
 WS = 198; WF = 182 mm
 L = 670-2200 mm
 H = 18, 25-150 mm
 A + B ≥ 670 mm
 A + B + C ≥ 1340 mm



DECO d 450, h 122 mm
 W1 = 500 (497-600) mm*
 W2 = 450 (415-600) mm*
 WS = 204; WF = 238 mm
 L = 470-2200 mm
 H = 18, 25-150 mm
 A + B ≥ 470 mm
 A + B + C ≥ 940 mm

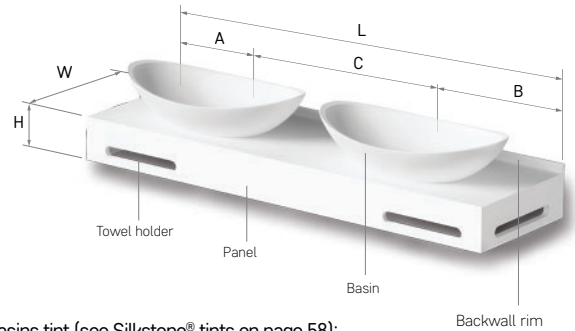

ROUND ON d 410, h 140 mm
 W1 = 400 (390-600) mm*
 W2 = 350 (305-600) mm*
 WS = 245; WF = 90 mm
 L = 430-2200 mm
 H = 18, 25-150 mm
 A + B ≥ 430 mm
 A + B + C ≥ 860 mm



FELICE 690 × 375, h 158 mm
 W1 = 450 (405-600) mm*
 W2 = 350 (320-600) mm*
 WS = 228; WF = 122 mm
 L = 710-2200 mm
 H = 18, 25-150 mm
 A + B ≥ 710 mm
 A + B + C ≥ 1420 mm

Indicate the PAA washbasins tint (see Silkstone® tints on page 58):

MATTE WHITE

Surface with washbasin of another manufacturer

TINTED: _____

Surface without washbasin

GRAPHITE

Tolerated error of the positioning of cut-outs and milling on the surface +/-5 mm.

*W1 (mixer tap on the surface). W2 (mixer tap from the wall). Attention! The surface of the drain cover is made from the same material as the washbasin.

2. Mark the number of basins you need / write down the key measures of your countertop / mark if you need towelholder (300 x 35 mm)** / fully mark ▽ to show panel location:

** Towel holder (TH1&TH2) is available only if the height of the panel (H) is at least 100 mm and the possible position is defined by the manufacturer.

3. Mark the type of mixer tap placement, indicate the position of the mixer and the washbasin

(If WS and WB are not indicated, then the dimensions indicated in the standard drawings are used for the location of the washbasin and mixer tap, cut-outs in the surface are included in the basic set and in the price, if a PAA washbasin is ordered):

MIXER TAP ON COUNTERTOP SURFACE***

MIXER TAP FROM WALL
(write mixer tap lenght MIX)

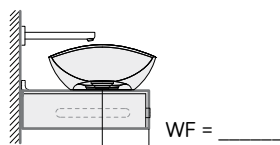
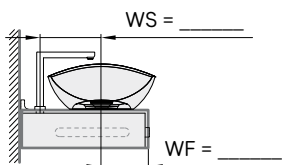

4. Mark the surface location in the room:

Surface on furniture***

5. Mark if you need backwall rim (h = 30 mm) and wall panel (h = 60-400 mm), backwall rim and wall panel (thickness = 12 mm) and length equal to surface length (L):

backwall rim (h = 30 mm) wall panel h = _____ mm (h = 60 - 400 mm) NO

6. Mark countertop & wall panel colour (Specify a tint name):

MATTE WHITE TINTED _____ GRAPHITE

7. Mark if brackets are needed

(see recommended number of brackets below)***:

1 pcs. 2 pcs. NO
 3 pcs. (L ≥ 1200 mm) 4 pcs. (L ≥ 1600 mm) integrated brackets (H ≥ 100 mm), included in the price

8. Mark if it is necessary: rounding of the corner(s) of the surface (possible only if the edge height is 18 / 25 mm), cutting, milling or drilling:

Rounding*** Milling
 Cutting*** Drilling
 NO

9. Special marks:

*** IMPORTANT! It is required that all the items of the form are filled in and a drawing is included with the order, specifying the position of the basins, the cut-outs for installing the mixer taps, any rounded corners and cuts, as well as any non-standard solutions: i.e. bevelled surfaces, cutouts, unusually narrow surfaces without cut-outs for installing the mixer taps (wall-mounted mixer taps) etc. The integrated brackets are included in the price and are only available if H is greater than 100 mm. The metal mounting brackets must be ordered for an additional fee if the load capacity of the wall is not sufficient or if the H value of the surface is less than 100 mm, not required if the washbasin is placed on furniture.

Made to Measure shelves

400-2200 × 100-450 mm, h= 80 mm

Surface width (W), mm	TINT	Length of surface (L), mm					Non-standard sizes & shapes
		400-600	601-1000	1001-1400	1401-1800	1801-2200	
W = 100-350	Matte White	380	540	670	830	950	Upon request
	tinted	440	630	770	940	1100	
	GRAPHITE	530	730	910	1110	1280	
W = 351-450	Matte White	460	600	770	940	1100	Upon request
	tinted	530	700	880	1080	1270	
	GRAPHITE	610	810	1050	1270	1480	



Shelf is available: Matte White and tinted, see Silkstone® tints on page 58. Indicate the shelf length and tint in the order notes. Wall mountings – integrated

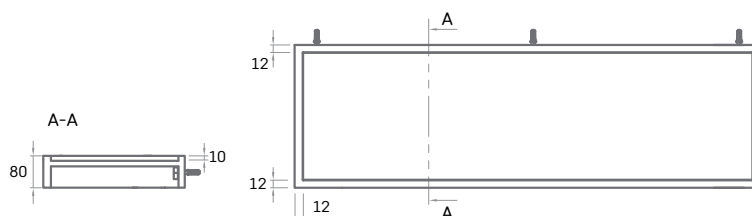
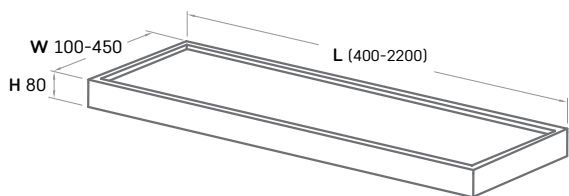

SOLID
800 × 450 × 95 mm
1200 × 450 × 95 mm
1600 × 450 × 95 mm

Countertop in solid oak 800 × 450 × 95	360	MBPS0800x450
Countertop in solid oak 1200 × 450 × 95	440	MBPS01200x450
Countertop in solid oak 1600 × 450 × 95	480	MBPS01600x450

Brackets included
SOLID surfaces are compatible with DECO, AMORE, BELLA, FELICE and ROUND ON washbasins

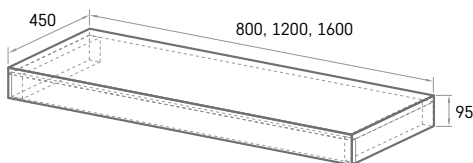

Made to Measure
wall panels

H 60-400 × L 430-2200 mm

Panel height (H), mm	TINT	Panel length (L), mm								Non-standard sizes & shapes
		430-800	801-1000	1001-1200	1201-1400	1401-1600	1601-1800	1801-2000	2001-2200	
W = 60-200	Matte White	130	140	170	200	210	240	300	310	Upon request
	tinted	140	170	200	210	280	300	310	360	
	GRAPHITE	160	190	230	270	300	340	380	430	
W = 201-400	Matte White	210	300	340	410	460	500	570	630	Upon request
	tinted	270	310	380	460	530	580	670	730	
	GRAPHITE	300	380	460	540	600	680	770	840	

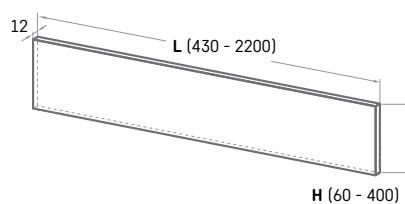

Item	Description	Price EUR		Art. NR.
		White	In colour	White / In colour



BELLA
650 × 390 mm
h = 160 mm
Mounted on the surface without overflow

Washbasin in Cast Stone with drain	560	850	IBELL/xx
Silkstone® washbasin with drain	610	780	IBELS/xx
GRAPHITE washbasin with drain		900	IBELS/01

See Silkstone® tints on page 58./ Cast Stone colours on page 57

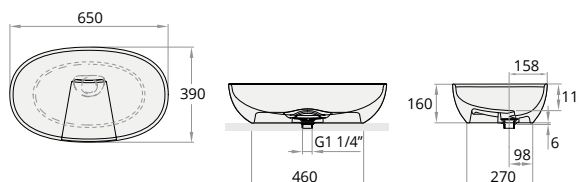

FELICE
690 × 375 mm
h = 158 mm
Mounted on the surface without overflow

Silkstone® washbasin with drain*	540	660	IFES/xx
GRAPHITE washbasin with drain*		770	IFES/01

* The surface of the drain cover is made of the same material and tint as the washbasin. See Silkstone® tints on page 58.

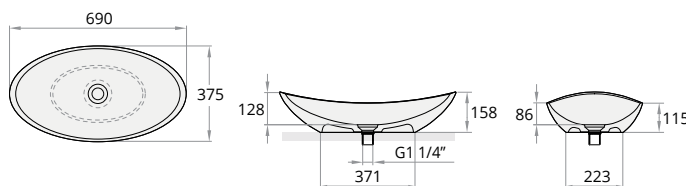

* Drain



AMORE
600 × 370 mm
h = 195 mm
Countertop washbasin, overflow not available

Washbasin in Cast Stone with drain*	530	700	IAMO/xx
Silkstone® washbasin with drain*	570	760	IAMS/xx
GRAPHITE washbasin with drain*		860	IAMS/01

* The surface of the drain cover is made of the same material and tint as the washbasin. See Silkstone® tints on page 58./ Cast Stone colours on page 57

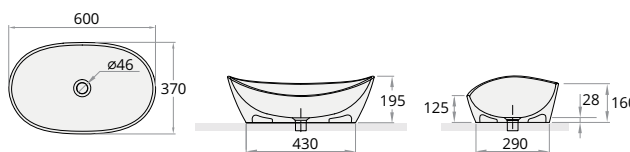

* Drain



PERLA
510 × 355 mm
h = 142 mm
Mounted on the surface without overflow

Washbasin in Cast Stone with drain	470	640	IPERL/xx
Silkstone® washbasin with drain	540	700	IPERLS/xx
GRAPHITE washbasin with drain		800	IPERLS/01

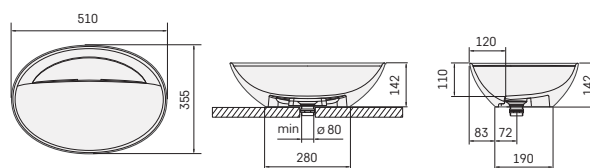

Item	Description	Price EUR		Art. NR.
		White	In colour	White / In colour



QUADRO
 700 × 430 mm
 h = 137 mm
 Mountable on the wall
 or on the surface
 without overflow

Washbasin in Cast Stone with drain	560	740	IQUA/xx
Silkstone® washbasin with drain	610	780	IQUAS/xx
GRAPHITE washbasin with drain		900	IQUAS/01

Washbasin with integrated wall mountings. Tinted whole washbasin.
 See Silkstone® tints on page 58./ Cast Stone colours on page 57

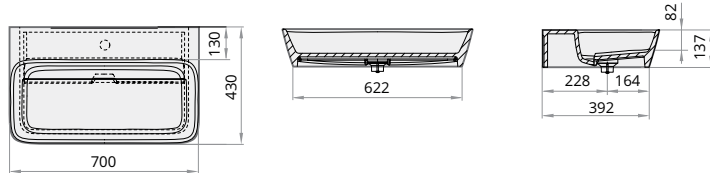

QUADRO ON
 555 × 335 mm
 h = 125 mm
 Mountable on the wall
 or on the surface
 without overflow

Washbasin in Cast Stone with drain	470	640	IQUAON/xx
Silkstone® washbasin with drain	530	700	IQUASON/xx
GRAPHITE washbasin with drain		800	IQUASON/01

Tinted whole washbasin.
 See Silkstone® tints on page 58./ Cast Stone colours on page 57

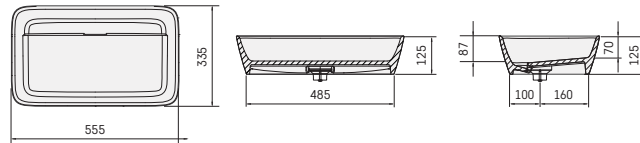

INFINITY 80
 800 × 470 mm
 h = 95 mm
 Mountable on the wall
 or on the surface
 without overflow

Silkstone® washbasin with drain	780	970	IINF8/xx
---------------------------------	-----	-----	----------

Washbasin with integrated wall mountings. Tinted whole washbasin.
 See Silkstone® tints on page 58.

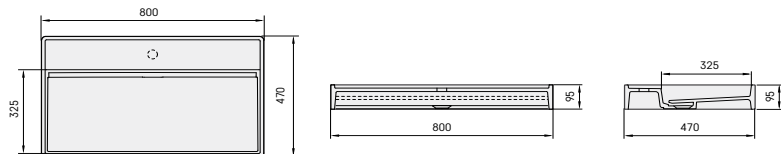

INFINITY 60
 600 × 470 mm
 h = 95 mm
 Mountable on the wall
 or on the surface
 without overflow

Silkstone® washbasin with drain	680	860	IINF60/xx
---------------------------------	-----	-----	-----------

Washbasin with integrated wall mountings. Tinted whole washbasin.
 See Silkstone® tints on page 58.

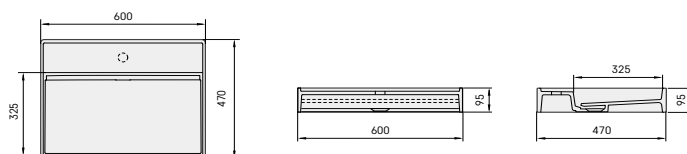

Item	Description	Price EUR		Art. NR.
		White	In colour	White / In colour



DECO
 ø 450 mm
 h = 122 mm
 Countertop washbasin,
 overflow not
 available

Washbasin in Cast Stone with drain*	370	480	IDEC/xx
Silkstone® washbasin with drain*	480	640	IDECS/xx
GRAPHITE washbasin with drain*		760	IDECS/01

To install the washbasin on the surface - additional min. Ø120 mm cut-out in surface should be drilled

* The surface of the drain cover is made of the same material and tint as the washbasin.
 See Silkstone® tints on page 58.

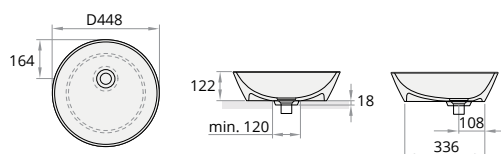

* Drain



ROUND ON
 ø 410 mm
 h = 140 mm
 Countertop washbasin,
 overflow not
 available

Washbasin in Cast Stone	290	460	IROON/xx
Silkstone® washbasin with drain*	380	530	IROSON/xx
GRAPHITE washbasin with drain*		630	IROSON/01

* The surface of the drain cover is made of the same material and tint as the washbasin.
 See Silkstone® tints on page 58./ Cast Stone colours on page 57



* Drain



VARIO
 595 × 470 mm
 h = 150 mm
 Mountable on the wall or
 on the surface

Washbasin in Cast Stone	340	470	IVAR/xx
-------------------------	-----	-----	---------

Washbasin with integrated screw places

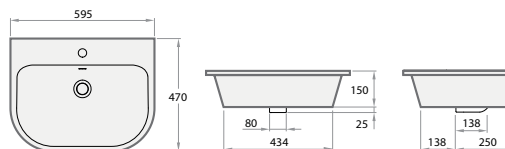

* Optional:

Permanent open drain in metal, chrome colour cover	90		L2264
Permanent open drain with Silkstone® cover	90	100	DEIZSNOP/xx
Permanent open drain with GRAPHITE		100	DEIZSNOP/01
Permanent open drain with Cast Stone cover	90	100	DKIZPBNOP/xx

Item	Description	Price EUR		Art. NR. White / In colour
		White	In colour	



OVO IN
550 × 372 mm
h = 170 mm
Drop-in washbasin

Overflow available
optionaly

Washbasin in Cast Stone*	260	400	IOVIN/xx
Silkstone® washbasin*	310	480	IOVSIN/xx
GRAPHITE washbasin*		600	IOVSIN/01

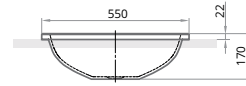
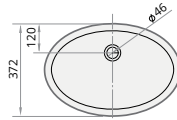

ROUND IN
ø 440 mm
h = 140 mm
Drop-in washbasin

Overflow available
optionaly

Washbasin in Cast Stone*	290	460	IROIN/xx
Silkstone® washbasin*	370	510	IROSIN/xx
GRAPHITE washbasin*		630	IROSIN/01

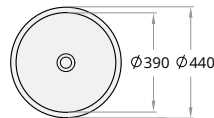

OPUS IN
520 × 320 mm
h = 130 mm
Drop-in washbasin

Overflow available
optionaly

Silkstone® washbasin*	360	410	IOPSIN/xx
GRAPHITE washbasin*		500	IOPSIN/01

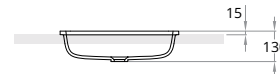
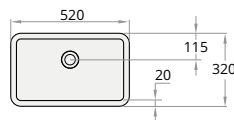

ORGANIC IN
690 × 480 mm
h = 185 mm
Drop-in washbasin
witout overflow

Washbasin in Cast Stone*	400	530	IORG/xx
--------------------------	-----	-----	---------

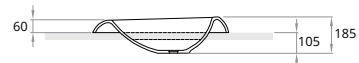
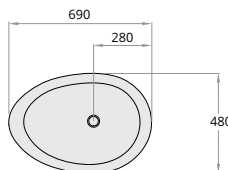

Item	Description	Price EUR		Art. NR.
		White	In colour	White / In colour



LONG STEP 70
700 × 490 mm
h = 110 mm

Washbasin in Cast Stone	340	470	ILS700/xx
-------------------------	-----	-----	-----------

Washbasin with integrated screw places

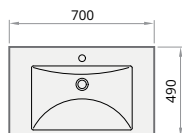

LONG STEP 100
1000 × 490 mm
h = 110 mm

Washbasin in Cast Stone	410	540	ILS1000/xx
-------------------------	-----	-----	------------

Optional:

Brackets, 2 pcs., white or satin colour	90		IZKLS/xx
---	----	--	----------

Brackets, 2 pcs., stainless steel	40		IZKLS/NT
-----------------------------------	----	--	----------

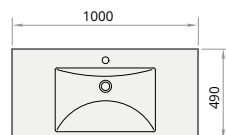

LONG STEP 150
1500 × 490 mm
h = 110 mm

Washbasin in Cast Stone - right side basin	560	670	ILS1500/D/xx
--	-----	-----	--------------

Washbasin in Cast Stone - left side basin	560	670	ILS1500/A/xx
---	-----	-----	--------------

Washbasin in Cast Stone - centered basin	560	670	ILS1500/xx
--	-----	-----	------------

Optional:

Brackets, 2 pcs., white or satin colour	90		IZKLS/xx
---	----	--	----------

Brackets, 2 pcs., stainless steel	400		IZKLS/NT
-----------------------------------	-----	--	----------

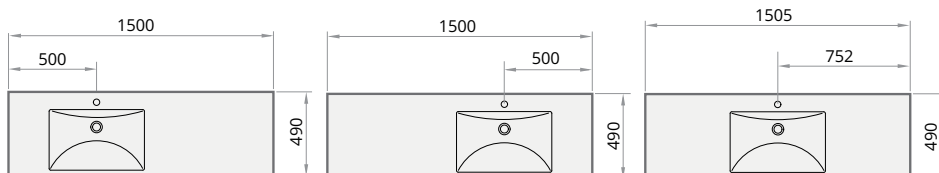

LONG STEP 1500/A

LONG STEP 1500/D

LONG STEP 1500



LONG STEP DUO
2010 × 490 mm
h = 110 mm

Double Washbasin in Cast Stone	760	880	ILSW/xx
--------------------------------	-----	-----	---------

Optional:

Brackets, 3 pcs., white or satin colour	110		IZKLSW/xx
---	-----	--	-----------

Brackets, 3 pcs., stainless steel	580		IZKLSW/NT
-----------------------------------	-----	--	-----------

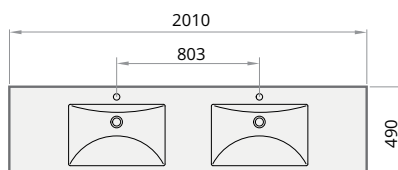

Stainless steel brackets
for washbasins LONG STEP 1000,
LONG STEP 1500, LONG STEP DUO

Item	Description	Price EUR		Art. NR. White / In colour
		White	In colour	

LOTO MINI

500-1200 x 400 mm
h = 18 mm

Mountable on the wall
or on furniture.
Overflow not available.

Washbasin in Cast Stone

LOTO MINI 50 (500 mm)	340	480	IMLOT500/xx
LOTO MINI 60 (600 mm)	370	510	IMLOT600/xx
LOTO MINI 70 (700 mm)	400	540	IMLOT700/xx
LOTO MINI 80 (800 mm)	410	560	IMLOT800/xx
LOTO MINI 100 (1000 mm)	440	580	IMLOT1000/xx
LOTO MINI 120 (1200 mm)	470	610	IMLOT1200/xx
LOTO MINI 50-120 (500-1200 mm*)	510	670	IMLOT500-1200/xx

Optional:

Bracket, 310 mm 1 pc., white	60		IZKSS310GB1/00
Permanent open drain in metal, chrome colour cover	90		L2264
Permanent open drain with Cast Stone cover	90	100	DKIZPBNOP/xx

* LOTO MINI washbasin is available in custom length from 500 to 1200 mm

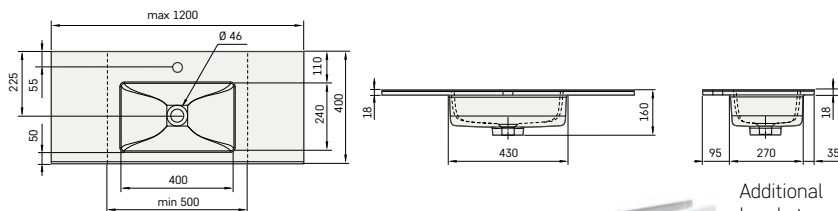

LOTO

600-1200 x 490 mm
h = 18 mm

Mountable on the wall
or on furniture.
Overflow not available.

Washbasin in Cast Stone







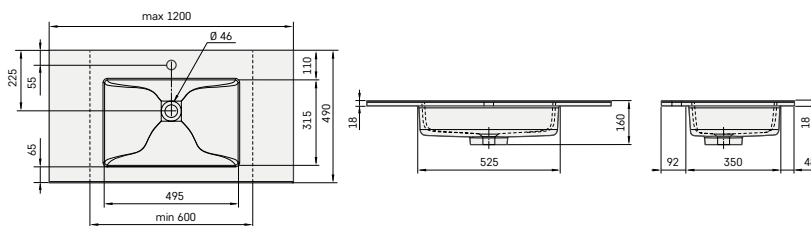

LOTO 60 (600 mm)	370	510	ILOT600/xx
LOTO 70 (700 mm)	400	540	ILOT700/xx
LOTO 80 (800 mm)	410	560	ILOT800/xx
LOTO 100 (1000 mm)	440	580	ILOT1000/xx
LOTO 120 (1200 mm)	470	610	ILOT1200/xx
LOTO 60-120 (600-1200 mm*)	510	670	ILOT600-1200/xx

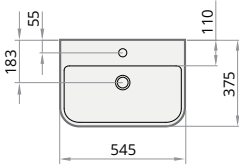
Optional:

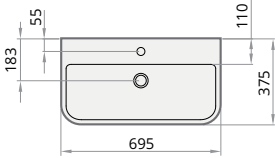
Bracket, 400 mm 1 pc., white	60		IZKSS400GB1/00
Permanent open drain in metal, chrome colour cover	90		L2264
Permanent open drain with Cast Stone cover	90	100	DKIZPBNOP/xx

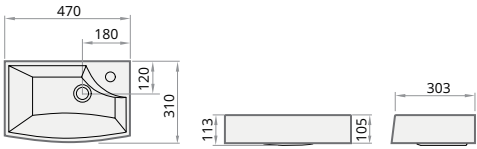
* LOTO washbasin is available in custom length from 600 to 1200 mm

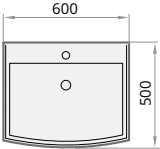

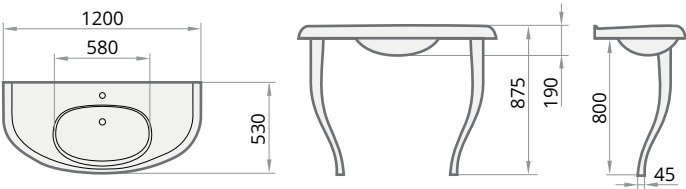
Item	Description	Price EUR		Art. NR.
		White	In colour	White / In colour
 <p>SAMBA 55 545 × 375 mm h = 139 mm</p>	Washbasin in Cast Stone	240	370	IMSA/xx
	Optional: Brackets, 2 pcs., white	70		IZKSA/00
	  <p>Brackets</p>			
 <p>SAMBA 70 695 × 375 mm h = 139 mm</p>	Washbasin in Cast Stone	300	430	ISA/xx
	Optional: Brackets, 2 pcs., white	70		IZKSA/00
	  <p>Brackets</p>			
 <p>STEP MINI 470 × 310 mm h = 105 mm without overflow</p>	Washbasin in Cast Stone	190	310	IMST/xx
	Optional: Brackets, 2 pcs., white	60		IZKMST/00
	<p>Cut-out for mixer tap available only on right side</p>   <p>Brackets</p>			
 <p>STEP 600 × 500 mm h = 120 mm</p>	Washbasin in Cast Stone	310	440	ISTE/xx
	Optional: Brackets, 2 pcs., white	60		IZKTR/00
	  <p>Brackets</p>			
 <p>VICTORIA 1200 × 530 × 190 mm h = 875 mm</p>	Washbasin in Cast Stone with legs	1070		IVICK/00
	Washbasin in Cast Stone without legs	600	740	IVIC/xx
				

Item	Description	Price EUR		Art. NR. White / In colour
		White	In colour	

BETA
800-2000 × 540 mm
h = 170 mm



Washbasin in Cast Stone

BETA 80-100 (800-1000 mm*)	400	560	IB1000/xx
BETA 100-150 (1001-1500 mm*)	560	700	IB1500/xx
BETA 150-200 (1501-2000 mm*)	610	740	IB2000/xx

Optional:

Brackets, 2 pcs., white or satin colour	100		IZKL/xx
Brackets, 2 pcs., stainless steel	110		IZKL/NT

* BETA washbasin is available in custom length from 800 to 2000 mm

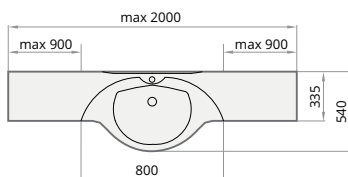

Brackets, rounded

BETA DUO
1620-2000 × 540 mm
h = 170 mm



Washbasin in Cast Stone 1620-2000 mm*	740	880	IBW2000/xx
---------------------------------------	-----	-----	------------

Optional:

Brackets, 3 pcs., white or satin colour	160		IZKLW/xx
Brackets, 3 pcs., stainless steel	170		IZKLW/NT

* BETA DUO washbasin is available in custom length from 1620 to 2000 mm

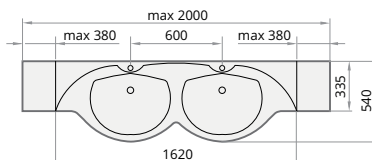

Brackets, rounded

DELTA
600 × 460 mm
900 × 460 mm
1200 × 460 mm
h = 180 mm



Washbasin in Cast Stone

DELTA 60 (600 mm)	230	360	IDE600/xx
DELTA 90/A (900 mm - right side basin)	290	410	IDE900/D/xx
DELTA 90/D (900 mm - left side basin)	290	410	IDE900/A/xx
DELTA 120 (1200 mm - centered basin)	330	470	IDE1200/xx

Optional:

Brackets, 2 pcs., white or satin colour	100		IZKL/xx
Brackets, 2 pcs., stainless steel	110		IZKL/NT

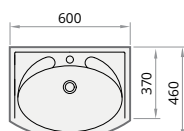

DELTA 60 (IDE600/xx)

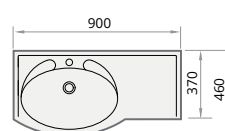

DELTA 90/A (IDE900/A/xx)

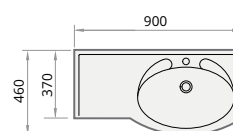

DELTA 90/D (IDE900/D/xx)

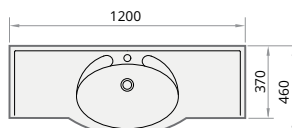

DELTA 120 (IDE1200/xx)



Brackets, rounded

All prices in EUR

Item	Description	Price EUR		Art. NR. White / In colour
		White	In colour	



CLARO MINI
600 × 500 mm
h = 90 mm

Maximum depth of washing machine 370 mm

Overflow option not available

Cast Stone wasbasin with kit*	410	570	KICLAMISIF/xx
-------------------------------	-----	-----	---------------

Optional:

Soap tray of another colour	60	90	DEIZTCLAMI/xx
-----------------------------	----	----	---------------

* Kit contains: soap tray, drain with outlet for washing machine, 2 white brackets

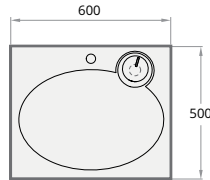

Brackets.



max. 370



CLARO
600 × 600 mm
h = 90 mm

Maximum depth of washing machine 470 mm

Overflow option not available

Cast Stone wasbasin with kit*	430	580	KICLASIF/xx
-------------------------------	-----	-----	-------------

Optional:

Soap tray of another colour	60	90	DEIZTCLA/xx
-----------------------------	----	----	-------------

* Kit contains: soap tray, drain with outlet for washing machine, 2 white brackets

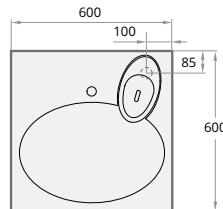

Brackets.



max. 470



CLARO GRANDE
600 × 750 mm
h = 100 mm

Maximum depth of washing machine 600 mm

Overflow option not available

Cast Stone wasbasin with kit*	560	710	KICLAGRSIF/xx
-------------------------------	-----	-----	---------------

Optional:

Soap tray of another colour	60	90	DEIZTCLAGR/xx
-----------------------------	----	----	---------------

* Kit contains: soap tray, drain with outlet for washing machine, 2 white brackets

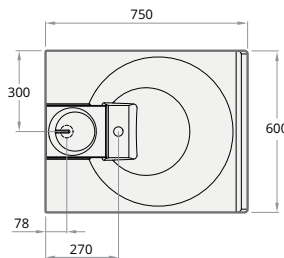

Brackets.



max. 600



DO 22
 ø 220 mm
 h = 108 mm
 Mountable on the surface,
 overflow
 not available

Description	Price EUR		Art. NR. White / In colour
	White	In colour	
Silkstone® washbasin*	170	240	IDOS/xx
Shelf for DO 22 washbasin in Silkstone®**	240	270	IDOPS/xx
Shelf for DO 22 washbasin in solid oak**	230		IDOPK

** Shelf with integrated screw places for wall mounting

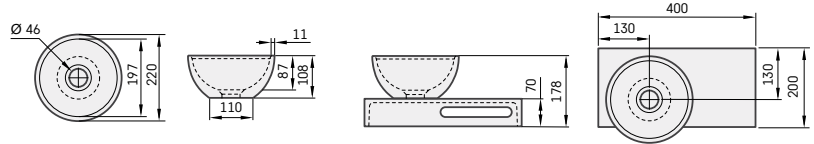

DO 25
 ø 250 mm
 h = 120 mm
 Mountable on the surface,
 overflow
 not available

Washbasin in Cast Stone*	185	245	IDO25/xx
Silkstone® washbasin*	215	245	IDOS25/xx
GRAPHITE washbasin*		285	IDOS25/01

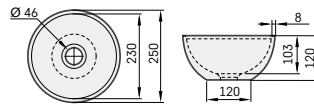

DO 28
 ø 280 mm
 h = 120 mm
 Mountable on the surface,
 overflow
 not available

Washbasin in Cast Stone*	215	285	IDO28/xx
Silkstone® washbasin*	245	285	IDOS28/xx
GRAPHITE washbasin*		330	IDOS28/01

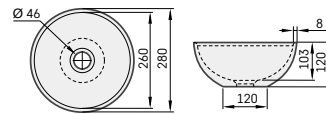

RE A/D
 400 × 210 mm
 h = 140 mm
 Mountable on the wall or on the surface,
 overflow
 not available

Silkstone® washbasin* (left/right side)	270		IRES/A/00; IRES/D/00
---	-----	--	----------------------

Washbasin with integrated screw places for wall mounting

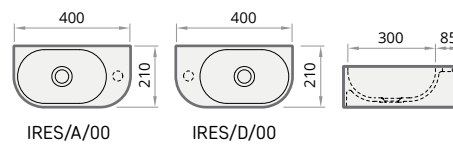

MI A/D
 400 × 210 mm
 h = 140 mm
 Mountable on the wall or on the surface,
 overflow
 not available

Silkstone® washbasin* (left/right side)	270		IMIS/A/00; IMIS/D/00
---	-----	--	----------------------

Washbasin with integrated screw places for wall mounting

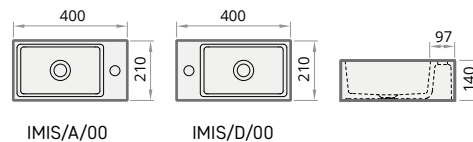

* Permanent open drain with Silkstone® cover

* Optional:

Permanent open drain with Silkstone® cover	90	100	DEIZSNOP/xx
Permanent open drain with Cast Stone cover	90	100	DKIZPBNOP/xx

Item	Description	Price EUR		Art. NR. White / In colour
		White	In colour	



CLASSIC KV
800 × 800 mm
900 × 900 mm
1000 × 1000 mm
h = 165 mm

CLASSIC KV80 with kit	340		KDPCLKV80/00
CLASSIC KV90 with kit	380		KDPCLKV90/00
CLASSIC KV100 with kit	460		KDPCLKV100/00
Optional - Siphon <i>TurboFlow</i> , ø 90 mm	60		0205302

Kit contains: shower tray, panel and adjustable legs



Siphon *TurboFlow*,
ø 90 mm

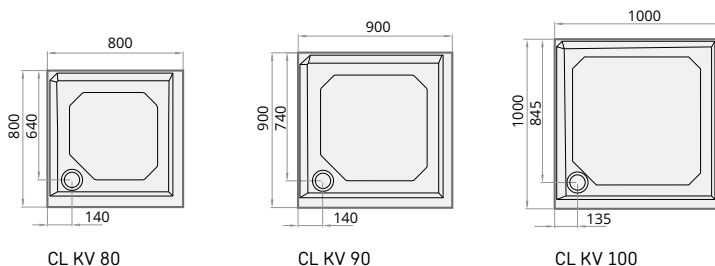

CLASSIC RO
800 × 800 mm
900 × 900 mm
1000 × 1000 mm
h = 165 mm

CLASSIC RO 80 R 550 with kit	340		KDPCLRO80/00
CLASSIC RO 90 R 550 with kit	380		KDPCLRO90R550/00
CLASSIC RO 90 R 500 with kit	380		KDPCLRO90R500/00
CLASSIC RO 100 R 550 with kit	480		KDPCLRO100/00
Optional - Siphon <i>TurboFlow</i> , ø 90 mm	60		0205302

Kit contains: shower tray, panel and adjustable legs

Siphon *TurboFlow*,
ø 90 mm

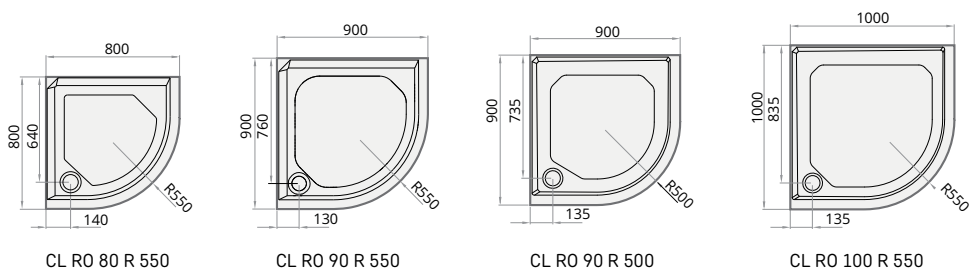

CLASSIC NEW
900 × 900 mm
h = 154 mm

CLASSIC NEW RO 90 R 550 with kit	380		KDPCLNRO90/00
Optional - Siphon <i>TurboFlow</i> , ø 60 mm	60		0205243

Kit contains: shower tray, panel and adjustable legs



Siphon *TurboFlow*,
ø 60 mm

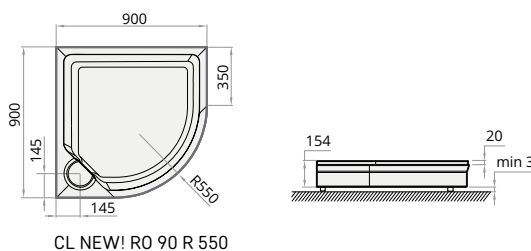

Item	Description	Price EUR		Art. NR. White / In colour
		White	In colour	
 <p>ART KV 800 × 800 mm 900 × 900 mm 1000 × 1000 mm h = 135 mm</p>	ART KV 80 with kit	310	440	KDPARTKV80/xx
	ART KV 90 with kit	340	480	KDPARTKV90/xx
	ART KV 100 with kit	510	630	KDPARTKV100/xx
	Optional - Siphon <i>TurboFlow</i> , ø 90 mm	60		0205302

Kit contains: shower tray, panel and adjustable legs

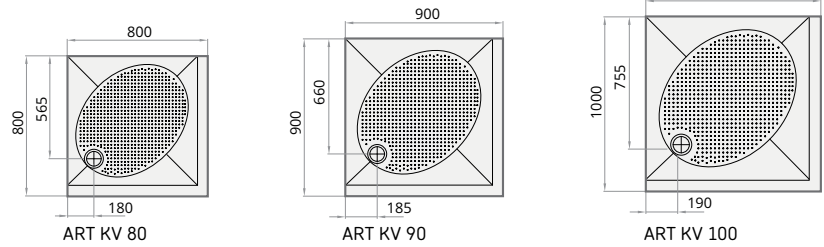

<p>ART RO 800 × 800 mm 900 × 900 mm 1000 × 1000 mm h = 135 mm</p>	ART RO 80 R 550 with kit	340	440	KDPARTRO80/xx
	ART RO 90 R 550 4W with kit	360	480	KDPARTRO90R550W/xx
	ART RO 90 R 500 with kit	360	480	KDPARTRO90R500/xx
	ART RO 100 R 550 with kit	510	610	KDPARTRO100/xx
	Optional - Siphon <i>TurboFlow</i> , ø 90 mm	60		0205302

Kit contains: shower tray, panel and adjustable legs

Siphon *TurboFlow*,
ø 90 mm

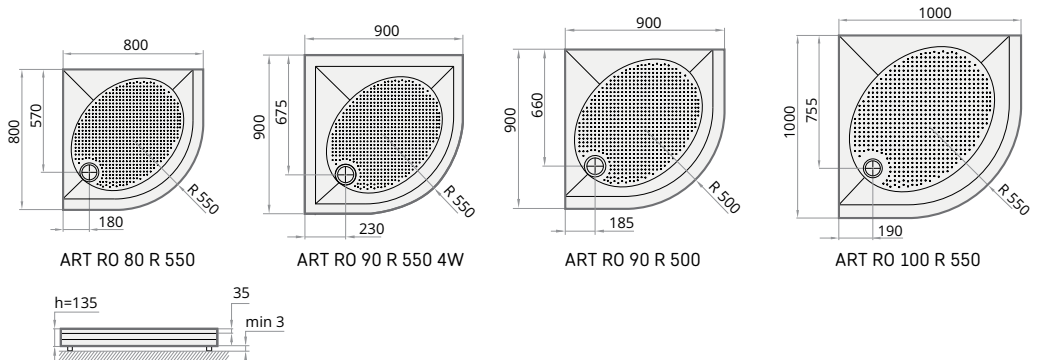

<p>ART 800 × 1200 mm 900 × 1200 mm h = 135 mm</p>	ART 80 × 120 with kit	480	630	KDPART80X120/xx
	ART 90 × 120 with kit	530	660	KDPART90X120/xx
	Optional - Siphon <i>TurboFlow</i> , ø 90 mm	60		0205302

Kit contains: shower tray, panel and adjustable legs

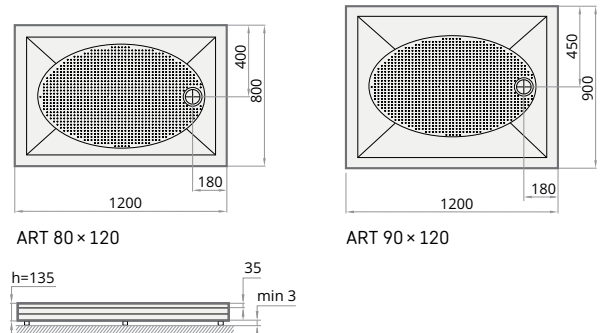

Item	Description	Price EUR		Art. NR. White / In colour
		White	In colour	



LARGO 80 x 100

LARGO
 800 x 1000 mm
 800 x 1400 mm
 800 x 1600 mm
 800 x 1700 mm
 900 x 1100 mm
 h = 135 mm

LARGO 80 x 100 with kit	470	610	KDPLARG80x100/00
LARGO 80 x 140 with kit	560	680	KDPLARG80x140/00
LARGO 80 x 160 with kit	660	780	KDPLARG80x160/xx
LARGO 80 x 170 with kit	710	910	KDPLARG80x170/xx
LARGO NEW 90 x 110 with kit*	530	660	KDPLARG90x110/xx
Optional - Siphon <i>TurboFlow</i> , ø 90 mm	60		0205302

* LARGO NEW 90x110 shower tray surface without standart grip
 Kit contains: shower tray, panel and adjustable legs



LARGO 80 x 170

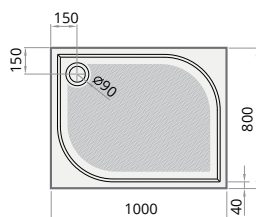

LARGO 80 x 100

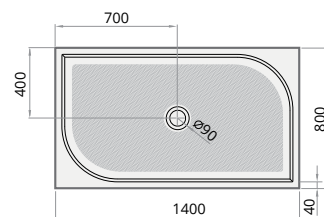

LARGO 80 x 140



LARGO NEW! 90 x 110*

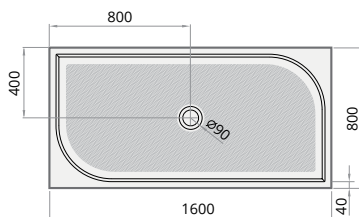

LARGO 80 x 160

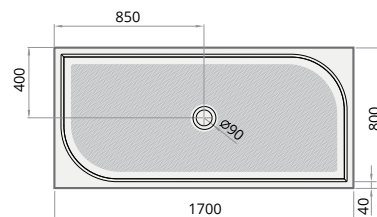

LARGO 80 x 170



Siphon *TurboFlow*,
 ø 90 mm

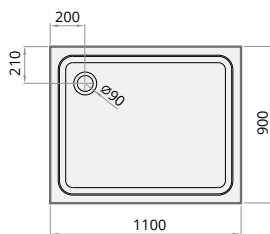

LARGO NEW! 90 x 110*

NEW

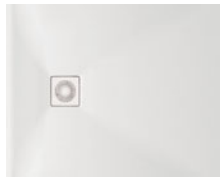

LETTERA 80 x 100

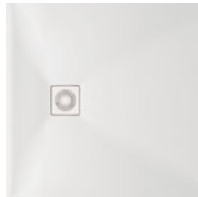

LETTERA KV 90

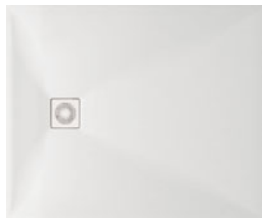

LETTERA 100 x 120

Item

Description

Price EUR

White

In colour

Art. NR.

White / In colour

LETTERA

Cast stone shower tray with a textured and matte surface.

- 800 x 1000 mm
- 800 x 1200 mm
- 900 x 900 mm
- 900 x 1000 mm
- 900 x 1200 mm
- 1000 x 1000 mm
- 1000 x 1200 mm

h = 30/
135 mm (with a panel)

LETTERA 80 x 100 with kit*	585	760	KDPLET80X100/xx
LETTERA 80 x 120 with kit*	615	800	KDPLET80X120/xx
LETTERA KV 90 with kit*	515	670	KDPLETKV90/xx
LETTERA 90 x 100 with kit*	615	800	KDPLET90X100/xx
LETTERA 90 x 120 with kit*	670	870	KDPLET90X120/xx
LETTERA KV 100 with kit*	670	870	KDPLETKV100/xx
LETTERA 100 x 120 with kit*	700	910	KDPLET100X120/xx

* The set includes: a cast stone shower tray, siphon, adjustable legs, as well as a panel and a drain cover in the color of the shower tray. Colours on page 57.

LETTERA 80 x 100**	470	610	DPLET80X100/xx
LETTERA 80 x 120**	515	670	DPLET80X120/xx
LETTERA KV 90**	415	540	DPLETKV90/xx
LETTERA 90 x 100**	515	670	DPLET90X100/xx
LETTERA 90 x 120**	570	740	DPLET90X120/xx
LETTERA KV 100**	570	740	DPLETKV100/xx
LETTERA 100 x 120**	600	780	DPLET100X120/xx

** Shower tray with color matching drain cover. Colours on page 57.

Optional:

LETTERA drain cover in stainless steel, satin white	30	DKDPLET/00
LETTERA drain cover in stainless steel, satin black	45	DKDPLET/01
LETTERA drain cover in stainless steel, semi-matt metal	45	DKDPLET/02
Siphon LETTERA 90 mm	45	HS1



Siphon *HS1*,
ø 90 mm



LETTERA
drain cover
130x130mm

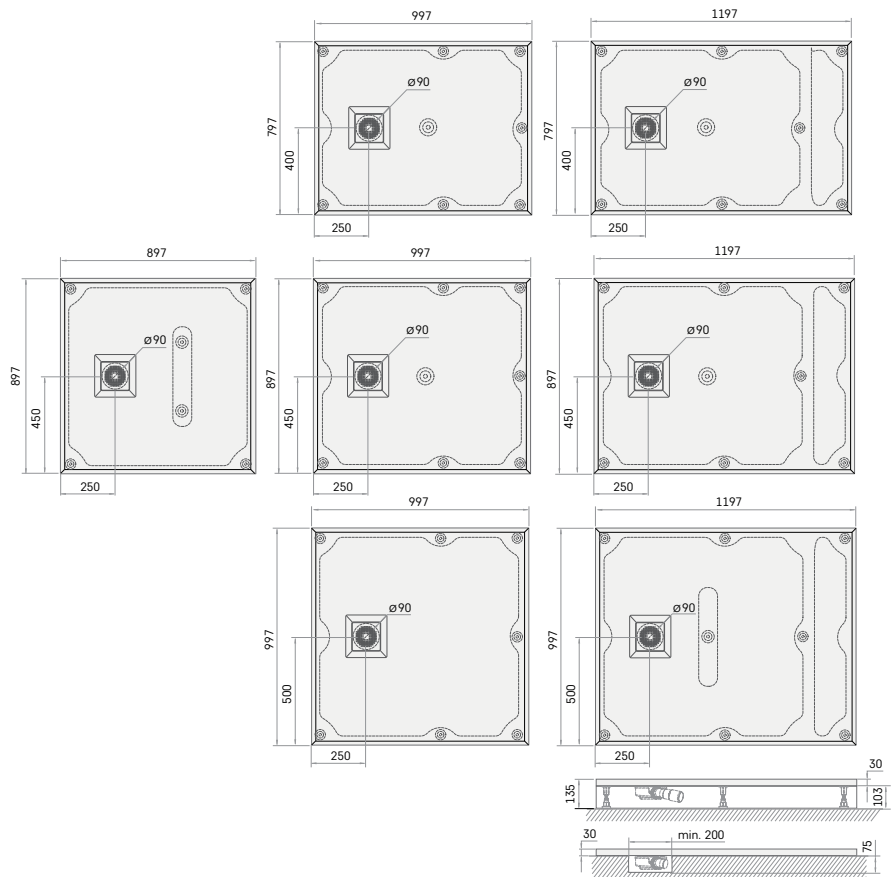

Price table for CRAFT Made to Measure shower tray

Material	Width (W), mm	Length (L), mm								
		900-1000	1001-1100	1101-1200	1201-1300	1301-1400	1401-1500	1501-1600	1601-1700	1701-1800
Cast Stone White, h=35 mm	800	630	680	740	810	870	930	1000	1050	1110
	801-900	700	760	840	910	980	1040	1110	1180	1250
	901-1000	770	860	930	1000	1080	1170	-	-	-
	Optional: Panel, h = 100 mm**	90								
	Shower tray in colour***	380								
	Siphon TurboFlow, ø 90 mm	60 (Art. NR. 0205302)								
Silkstone®** White, h=35 mm	800	1050	1150	1270	1370	1470	1570	1740	1780	1880
	801-900	1180	1300	1430	1540	1650	1770	1880	2000	2110
	901-990	1330	1450	1570	1710	1820	1950	-	-	-
	Optional: Panel, h = 110 mm**	160								

* Siphon with cover in Silkstone® cover included
 ** 90° angle between adjacent sides with panel is required
 *** Panel is always the same colour as shower tray

Adjustable legs, irregular angles, and cut-outs on sides are included in price. Tolerated error of dimensions for CRAFT Made to Measure shower tray is ±3 mm. Order form for CRAFT Made to Measure shower tray (see p. 55) has to be filled out, when placing an order.

Cast Stone shower tray siphon (optional)

Silkstone® shower tray siphon (included)



Siphon TurboFlow ø 90 mm



Siphon Viega Tempoplex Plus ø 90 mm*

CRAFT Made to Measure shower tray

900-1800 x 800-1000 mm*
 h = 35 / h = 135 mm (with panel)

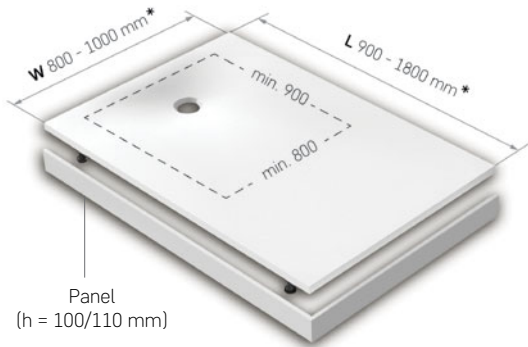

Panel (h = 100/110 mm)

Shower tray surface cut-out examples:



If the shower tray has narrow or wide angles between the edges, the dimensions W and L for the price table are determined according to the principle shown in the illustration

Additional information to consider when ordering a CRAFT shower tray

1. To ensure extra strength, all CRAFT shower trays are made with an additional layer of reinforcement. This means that if the shower tray is to be placed on a surface without legs, the surface must be prepared with an additional recess.

2. Taking into account the specifics of CRAFT shower tray production, due to the drop in shape, the edges of the shower tray may be offset from a straight plane.

Dimensions for Cast stone shower trays:

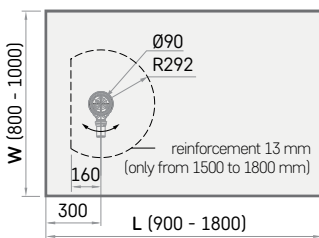

Dimensions for Silkstone® shower trays:

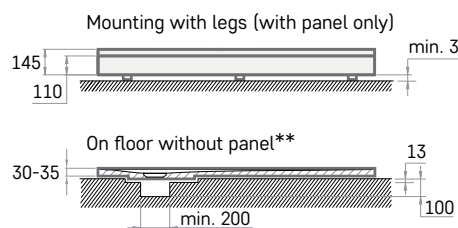
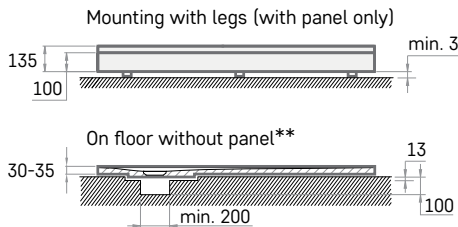
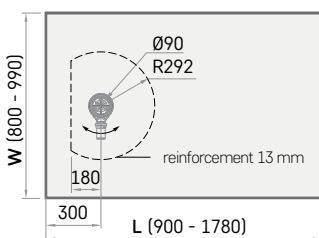

** 3 mm thick polypropylene must be laid between the shower tray and the surface

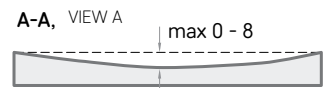
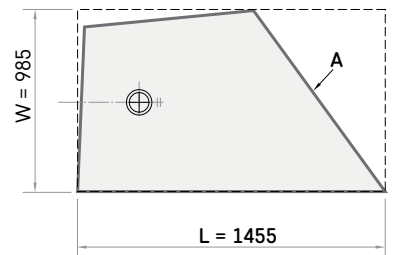

ORDER FORM FOR CRAFT MADE TO MEASURE SHOWER TRAY

1. Mark your choice of material:

- Cast Stone Silkstone®

2. Mark your choice of colour:

- White in colour*, (write the name): _____
**Only the cast stone shower tray can be colored*

3. Draw your shower tray:

- a) read suggestions on how to measure (top right corner);
- b) measure the place, where your shower tray will lay;
- c) draw perimeter of your shower tray in the grid:
 - the perimeter of shower tray has to fit within the perimeter of grid,
 - scaling of one grid box is 50 × 50 mm,
 - show measurements for all sides of your shower tray in the form of projections of these sides on the perimeter of grid below (see example to the right)

4. Mark the edges of the shower tray that will fit against the wall

5. Mark sides where panel is needed

6. Mark the mounting type of the shower tray:

- Assembly with legs Assembly without legs

7. Mark the shape of the shower tray:

- Rectangle (angles do not need to be indicated in the drawing)
 Irregular

8. Special remarks:

How to measure

1. All measurements have to be made:

- in millimeters
- for the height in which shower tray will be installed
- to walls with done finishing, e.g., walls with tiles

2. Make sure the walls are straight, to avoid unexpected gaps between the wall and shower tray

Example of shower tray drawing:

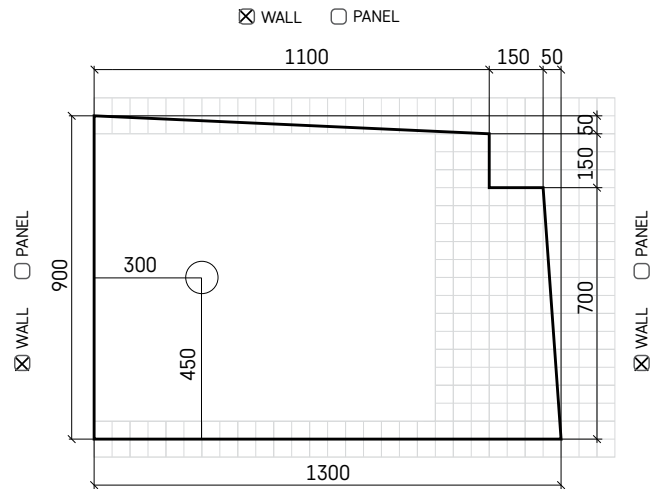

WALL PANEL
 The dimensions of the drawing are: DIMENSIONS FOR THE WALL
 DIMENSIONS FOR THE SHOWER TRAY

If the shower tray is to be placed in a niche, the tray length and width dimensions of the gauge must be reduced by 3 mm.

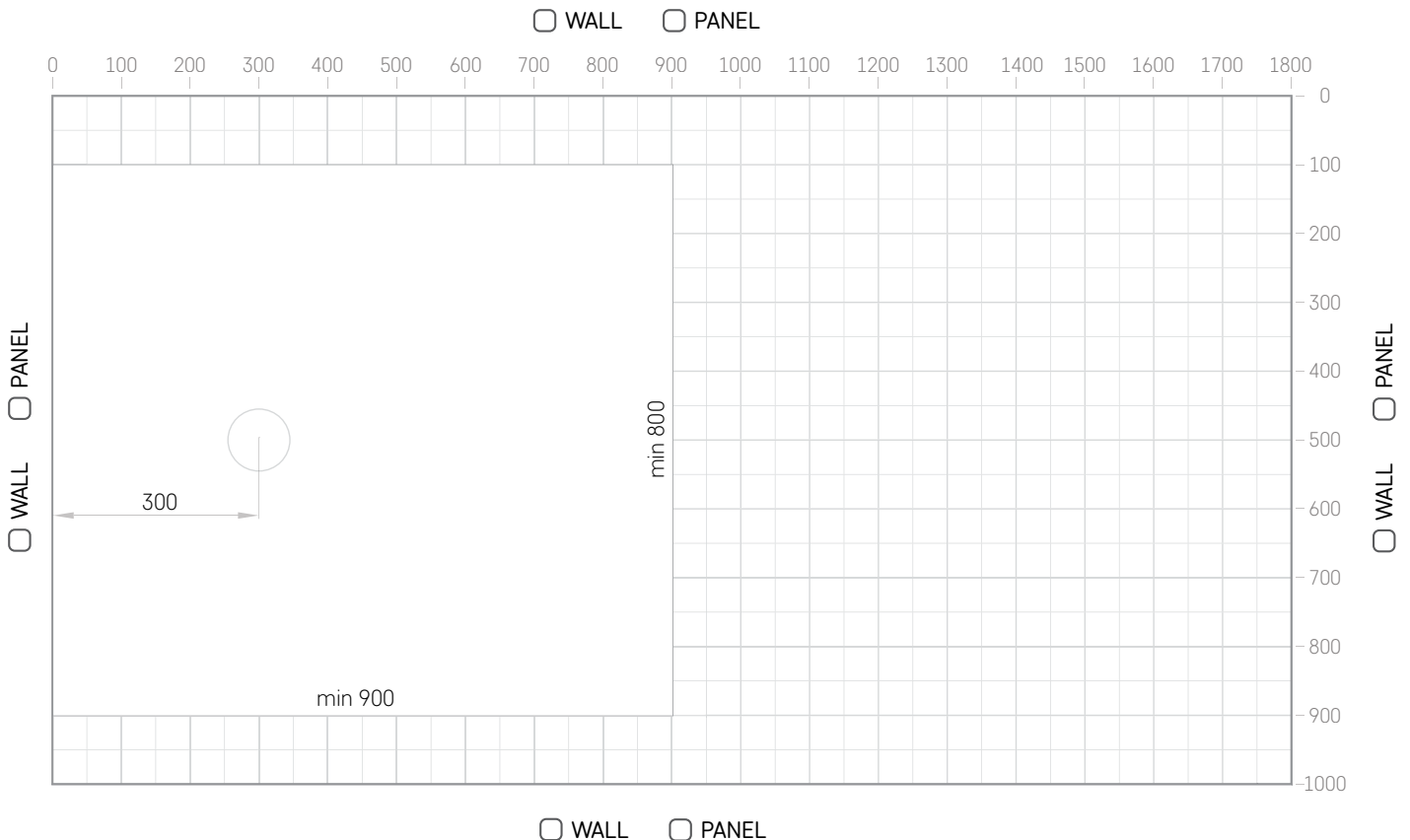

= 50 × 50 mm

SUGGESTIONS ON HOW TO PREPARE THE DRAWING OF A DECO SHAPE BATH

Each DECO SHAPE bath is one of a kind – made to the measures and drawing provided by client

How to measure

- All measurements have to be made:
 - in millimeters;
 - for the height of bath surface;
 - to walls with done finishing, e.g., walls with tiles.
- Make sure the walls are straight, to avoid unexpected gaps between the wall and bath

How to draw your bath

- Explore the illustration *Example of a bath drawing*
- Choose one side of grid in the drawing *Maximum size of a bath's surface* to represent a side of your bath that is next to the wall, then draw other walls that will border your bath
- Cut out (alongside dashed line) bath from the illustration *Minimum size of a bath* and see where it fits in your drawing, glue it once there is a perfect fit
- Draw the outer border(s) of your bath
 IMPORTANT! Mark the place for mixer tap and make sure that water supply is feasible there. The same goes for draining of water
- Show measures for all elements of your bath in the same manner, as in illustration *Example of a bath drawing*

Example of a bath drawing

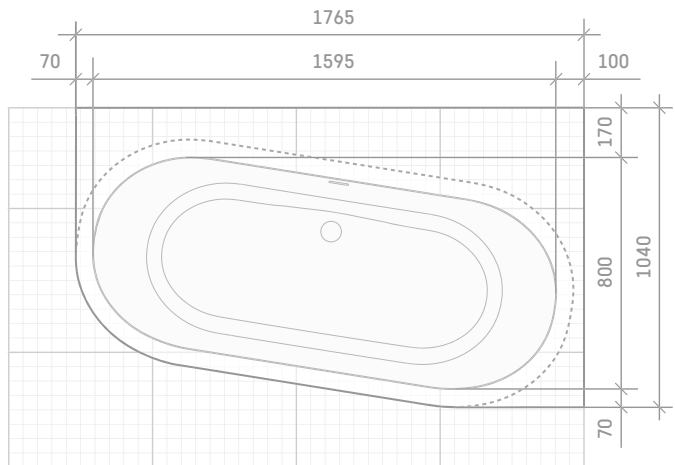

6. Indicate the location of the mixer tap cut-outs and their diameters in the drawing

7. Indicate the surface tint: _____

 = 50×50 mm

Maximum size of a bath's surface

2500 × 1250 mm; 1 box = 50 × 50 mm

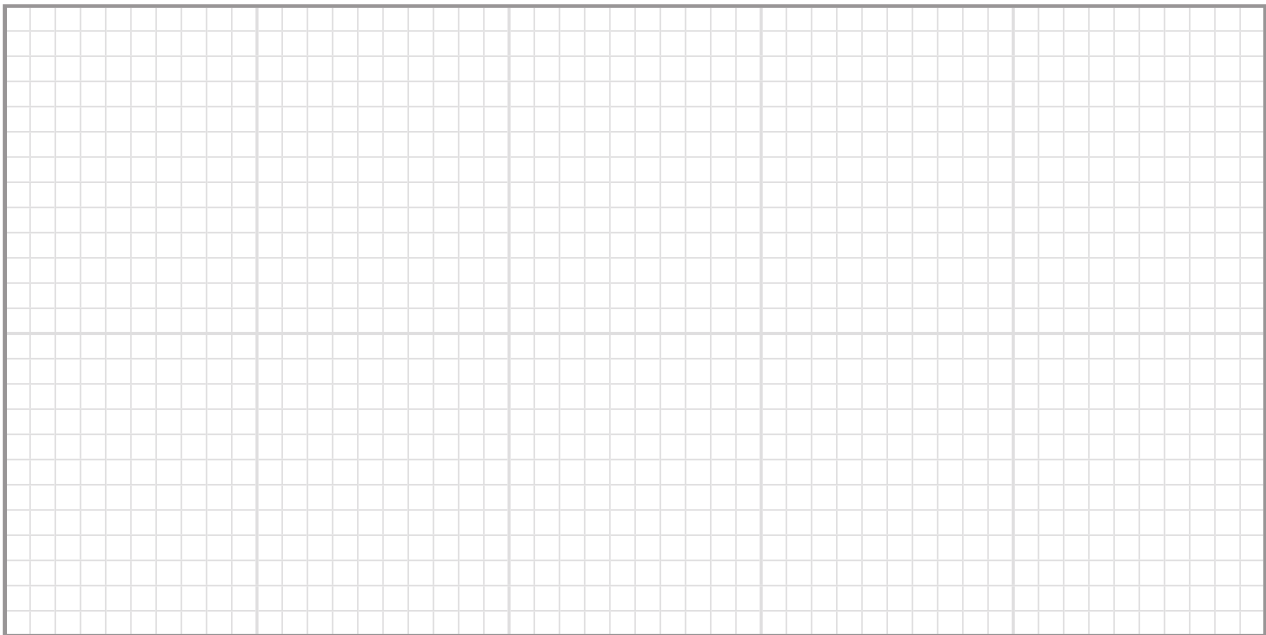

Minimum size of a bath 1660 × 750 mm

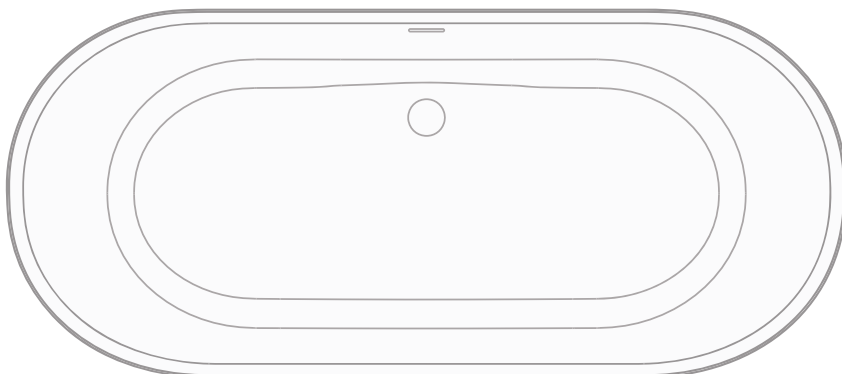

How to compose articles for orders of PAA products

Example of TRE 170 bath

Chosen options: Right side bath; Front panel, high; colour GLOSSY SILVER

1. Choosing appropriate articles:

VATREGR/D/xx – right side bath (replace xx with colour code and write the name of colour in brackets after the article)

PATREGRA/D/xx – panel for right side bath (the same actions, as for the bath)

2. Completing articles for the order:

VATREGR/D/01 (GLOSSY SILVER) + PATREGRA/D/01 (GLOSSY SILVER)

Example of VARIO L AD vbath

Chosen options: length 1660 mm; drain-overflow in metal, chrome colour; 2 rounded corners (A, D); colour: inside Glossy Alpine White, outside GLOSSY Grey (bath in two colours)

1. Choosing appropriate articles:

VAVARLAD/xx – bath (replace xx with colour code and write the name of colour in brackets after the article)

SIFVARM/H – drain-overflow in metal, chrome colour

2. Completing articles for the order:

VAVARLAD/01 (GLOSSY GREY / GLOSSY ALPINE WHITE) + SIFVARM/H

Explanation of symbols that are used in product articles after slash “/”

Cast Stone products

xx – to be replaced by the choice of colour:

00 – Glossy Alpine White

01 – indicates colour other than white

Silkstone® and GRAPHITE products

xx – to be replaced by the choice of colour:

00 – Matte White

01 – GRAPHITE

02 – tinted Silkstone® (for Made to Measure products see page 58.)

03 – Matte Grey

04 – Matte Caffelatte

A – Left side

D – Right side

Attention! when creating an article, in the order notes, mark whether a mono or duo tone bathtub is required (see example)

COLOUR CARD OF CAST STONE PRODUCTS

Product type	Product name	GLOSSY ALPINE WHITE (White)	COLOUR PALETTE*						
			CITY		JUICY		GRANITE		
			MONO**	DUO***	MONO	DUO	MONO	DUO	
Bathtubs	AMORE	+	FOG, CLAY						
	BELLA, BELLA OVO	+	FOG, CLAY						
	BEL CANTO	+	+	+	+	+	+		
	STEP	+	+	+	+	+	+	+	+
	VICTORIA (except GLOSSY BLACK)	+	+						
	VARIO M / L / XL	+	+	+	+	+	+	+	+
	QUADRO, QUADRO WALL / CORNER	+	FOG, CLAY						
	STORIA	+	FOG, CLAY						
	PERLA 145, PERLA 160, PERLA 175	+	FOG, CLAY						
	UNO 150 / UNO 170 / TRE 150 / TRE 170	+	+	+	+	+	+	+	+
VERSO	+	+	+	+	+	+	+	+	
Washbasins	AMORE	+	FOG, CLAY						
	BELLA	+	FOG, CLAY						
	ROUND ON	+	+	+	+				
	QUADRO	+	FOG, CLAY						
	VICTORIA (legs only GLOSSY ALPINE WHITE)	+	+		+			+	
	VARIO	+		+		+		+	
	ORGANIC IN, ROUND IN, OVO IN	+	+		+			+	
	LONG STEP collection	+	+		+			+	
	LOTO MINI / LOTO collection	+	+		+			+	
	Made to Measure washbasins	+	+		+			+	
	SAMBA 55/ SAMBA 70	+	+		+			+	
	STEP MINI / STEP	+	+		+			+	
	BETA, DELTA	+	+		+			+	
DO 25, DO 28	+	FOG, CLAY							
CLARO collection****	+	+		+			+		
Shower trays	CLASSIC	+							
	ART	+	+		+			+	
	CRAFT	+	+		+				
	LARGO	+	+		+			+	
	LETTERA		TEXTURED ALPINE WHITE	TEXTURED: FOG, CLAY GREY, SMOKE					

* CITY (GLOSSY GREY / GLOSSY FOG / GLOSSY SMOKE/ GLOSSY BLACK/ GLOSSY CLAY);

Attention! The GLOSSY BLACK tint is available for bathtubs only in the DUO range, but for washbasins and shower trays a tint is not available.

JUICY (GLOSSY BERRY / GLOSSY MANDARINE / GLOSSY APPLE / GLOSSY PLUM) (tints for shower trays are not available);

GRANITE (GLOSSY GOLD, GLOSSY SILVER, GLOSSY GALAXY, GLOSSY CASHMERE).

** MONO - bath in one color;

*** DUO - bath in two colours, the inside is always GLOSSY ALPINE WHITE, but the outside – in the chosen colour;

**** Claro collection - soap tray for white washbasin – in the chosen colour.

Individual tints, colours and their combinations are possible only upon agreement with the manufacturer and are not available in all cases.

TINT CARD OF SILKSTONE® PRODUCTS

Product type	Product name	TINT							
		Matte White	GRAPHITE	Matte Cappelatte	Matte Grey	Matte Shadow	Matte Desert	Matte Night	Matte Cemento
Made to Measure concept products	Made to Measure washbasin surface*	+				+	+	+	+
	Made to Measure ON TOP washbasin surface	+	+			+	+	+	+
	CRAFT shower trays	+							
	DECO SHAPE bath (tinted surface only)	+				+	+	+	+
	DECO SHAPE RE bath (tinted surface only)	+				+	+	+	+
	DECO SHAPE RE A/D bath (tinted surface only)	+				+	+	+	+
	FLOW	+							
	Made to Measure Silkstone shelves	+				+	+	+	+
	Made to Measure wall panels	+				+	+	+	+
Bathtubs	BELLA, BELLA OVO	+	+	+	+				
	FELICE	+	+	+	+				
	QUADRO	+	+	+	+				
	INFINITY (side panels tinted only)	+		+	+				
	AMORE	+	+	+	+				
	DOLCE	+	+						
	PERLA 145, PERLA 160, PERLA 175	+	+	+	+				
	DECO NUDO, DECO RIM	+	+	+	+				
	VICTORIA (legs also GRAPHITE)	+							
	DECO WALL	+	+	+	+				
DECO CORNER (only the surface of a bathtub is tinted)	+		+	+					
Washbasins	BELLA	+	+	+	+				
	FELICE	+	+	+	+				
	INFINITY 80, INFINITY 60	+		+	+				
	AMORE	+	+	+	+				
	QUADRO	+	+	+	+				
	ROUND ON	+	+	+	+				
	PERLA	+	+	+	+				
	DECO	+	+	+	+				
	OVO IN	+	+	+	+				
	ROUND IN	+	+	+	+				
	OPUS IN	+	+	+	+				
	DO 22, DO 22 washbasin shelf	+		+	+				
	DO 25, DO 28	+	+	+	+				
RE, MI	+								

* Basins always is Matte White

PAA EXTENDED WARRANTY TERMS

SIA "PAA" (PAA) has been producing baths, washbasins and shower trays since 1993. The PAA factory is located in Latvia, the European Union. The products are produced from high-quality materials and comply with EU norms. Properly cared for, they will last for decades, which is why PAA offers a warranty of ten years.



Warranty conditions:

1. PAA guarantees that its products – baths, shower trays and washbasins (Products) – will remain fully functional and will not alter their shape or colour, produce surface peeling, cracks or blisters (Defects):
 - a. for ten years from the date of purchase, regardless of the date of installation, if the Product is used in domestic conditions;
 - b. for two years from the date of purchase, if the Product is used in commercial or public facilities (for example, restaurants, offices, educational institutions, hotels, residences or sports centres, etc.).
2. PAA grants:
 - a. a four-year warranty for the components of the massage system, if the bathtub with a massage system has been installed by an authorised representative of the PAA;
 - b. a two-year warranty for massage system components, overflow drains, panels, fittings, wooden parts and other accessories.
3. All PAA Products feature the CE marking and comply with EU safety, health and environmental protection requirements.
4. If a Defect is discovered in the Product under the terms and conditions of this warranty, the Product will be repaired or replaced after due inspection. The replacement Product will have the same characteristics (material, dimensions, colour, etc.) as the original Product, unless this is not possible due to the discontinuation of production, in which case PAA will replace it with a Product with similar characteristics.
5. The PAA warranty is void:
 - a. if the Product has been damaged by third parties or the Owner during transportation, installation, maintenance or repair (except for in cases where installation, maintenance or repair was performed by a person authorised by PAA);
 - b. if the Product has been intentionally or unintentionally damaged by the Owner as a result of improper storage or use of the Product (e.g., exposure to the environment; exposure to excessive UV radiation; thermal shock when filling a cold bath with water hotter than 60 degrees Celsius; exposure to chemical and mechanical damage, etc.);
 - c. if the Product has been arbitrarily modified in any way;
 - d. if the Owner has failed to comply with the installation and operating instructions;
 - e. if Defects have been caused by external factors beyond the control of PAA (e.g., mains failure; poor water quality; thermostatic valve malfunction; lightning; fire; flood, etc.).
6. The PAA warranty does not apply to:
 - a. Natural wear and tear of the product (e.g., surface wear, scratches, dents, discolouration due to the sun's UV radiation, wear of seals and bathtub pads, etc.);
 - b. slight changes to the surface of the Product which are characteristic of the appearance of natural stone and do not affect its structural integrity;
 - c. unevenness on the underside of the Product that is not visible and does not affect its use.
7. PAA recommends leaving the installation of the Products to an authorised representative of PAA or another professional plumbing service.
8. PAA reserves the right to make minor changes to the appearance and design of the Product. The permissible length and width tolerances are +/-5 mm for dimensions up to 1 m and +/-10 mm for dimensions above 1 m.
9. When making a warranty claim to PAA, the buyer must present a valid proof of purchase and/or a PAA warranty card.
10. All transportation and installation costs associated with the replacement of the Product under this warranty shall be borne by the Owner.
11. By purchasing the Product, the Owner agrees that PAA shall not be liable for damages exceeding the amount specified in the original Product invoice and/or delivery note and/or receipt. PAA shall not be liable for damages not covered by this warranty:
 - a. including, but not limited to, liability for a product not fit for use, lost profits, lost business, inconvenience or moral damages to the owner;
 - b. indirect and consequential damages or penalties from third parties related to damage of the Product.

FOR NOTES:

