

# CLASSIC RO 90 R 500

## Informacje techniczne

Rozmiar: 900 x 900 mm, h = 165 mm

Ważyć: 22 kg

## Opcjonalny:

Syfon TurboFlow,  $\varnothing$  90 mm: 0205302



## RYSUNKI TECHNICZNE

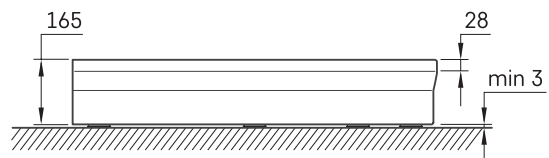
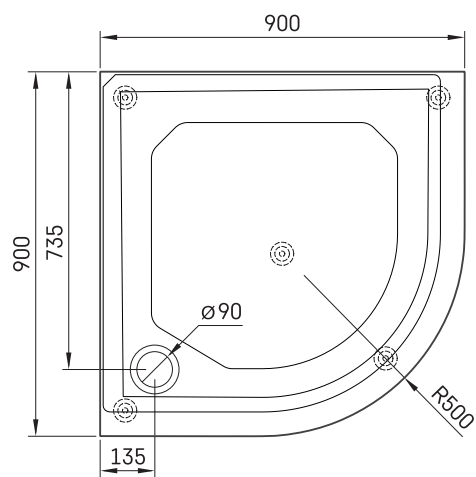

Zobacz produkt:

