

ART KV 90

Informacje techniczne

Wymiary zewnętrzne: 900 x 900 mm, h = 135 mm

Waga netto: 40 kg

Opcjonalnie :

Syfon TurboFlow, \varnothing 90 mm: 0205302

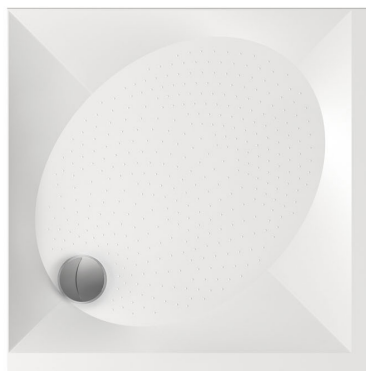

RYSUNKI TECHNICZNE

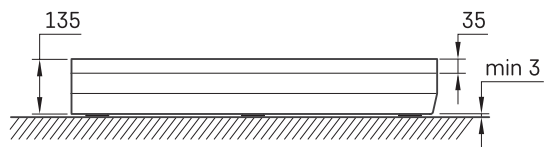
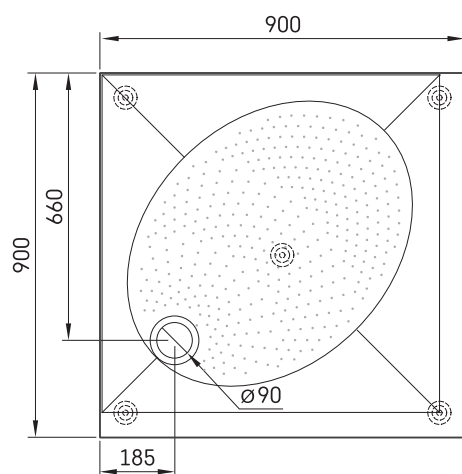

Zobacz produkt:

