

# Alba 35

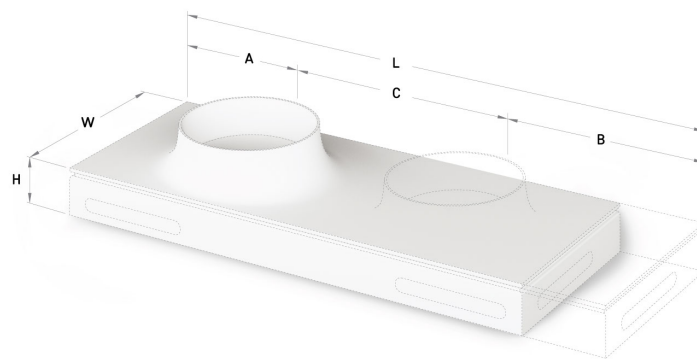

## INFORMAZIONI TECNICHE

Dimensione: 530 x 480 mm, h = 238 mm

Segmento di prodotto: **SIGN**

## DISEGNI TECNICI

