

Beta 80-100

TEHNILINE INFORMATSIOON

Mõõt: 800 x 540 mm, h = 170 mm

Kaal: 26 kg

Valikuline:

Kandurid valge või hall, 2 tk.: IZKL/xx

Kandurid, 2 tk., roostevaba teras: IZKL/NT



TEHNILISED JOONISED

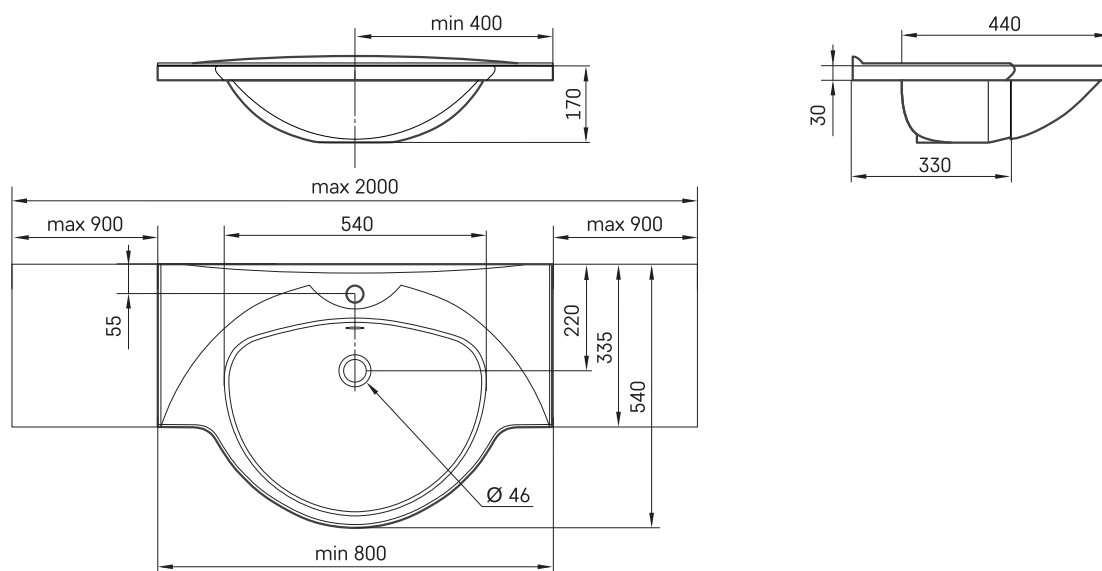

- LV leteicamā grīdas drenāžas zona
- LT kanalizacijos įvado montavimo grindyse zona
- EE Soovituslik põranda dreneazi asukoht
- EN Suggested floor drainage area
- RU Рекомендуемое место расположения дренажа в полу
- UA Зона підключення каналізації, що рекомендується
- PL Sugerowany obszar drenażu

Vaata toodet:

