

Loto Mini 100

TECHNICAL INFORMATION

Size: 1000 x 400 mm, h = 18 mm

Weight: 24 kg

Optional:

Brackets 310 mm: IZKSS310GB1/00

Permanent open drain in metal, chrome colour cover:
L2264

Permanent open drain with Cast Stone cover:
DKIZPBNOP/xx



TECHNICAL DRAWINGS

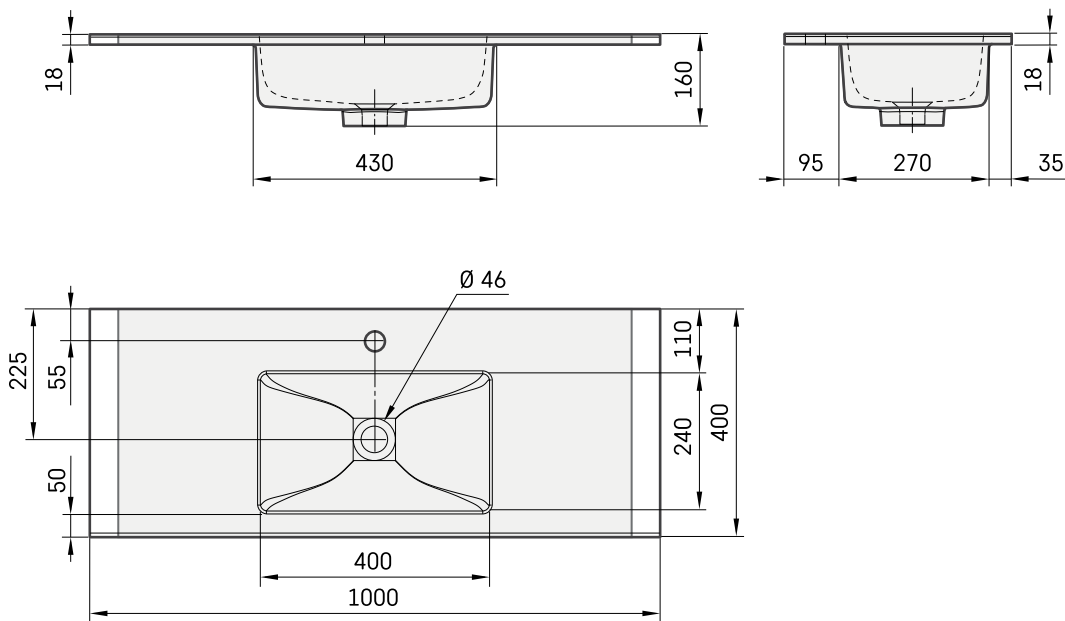

View product:

