

# Loto 60

## TECHNICAL INFORMATION

Size: 600 x 490 mm, h = 18 mm

Weight: 14 kg

### Optional:

Brackets 400 mm: IZKSS400GB1/00

Permanent open drain in metal, chrome colour cover:  
L2264

Permanent open drain with Cast Stone cover:  
DKIZPBNOP/xx



## TECHNICAL DRAWINGS

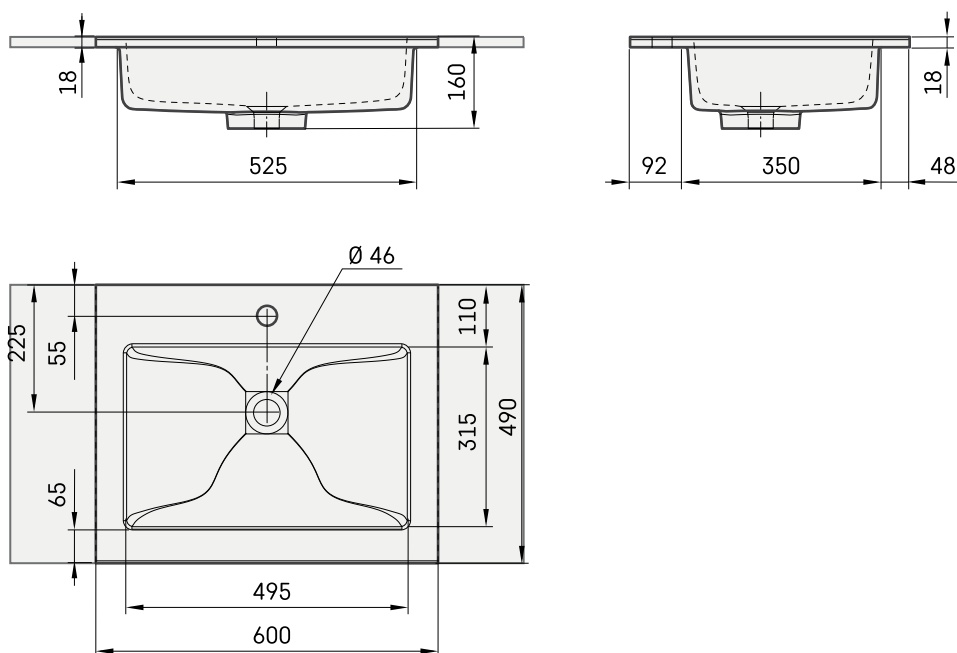

View product:

